

Executives

**dvo\_**

**dvo\_**



## Lifeful place for lifeful people

Dal lavoro ibrido alla realtà in continua evoluzione: anche DVO si rinnova, rivelando una doppia anima. Un progetto nel progetto. Dal design dei servizi alla gestione completa di una commessa o di un intero progetto speciale.

Siamo una service company che risponde ad ogni idea creativa con prodotti sostenibili, un servizio just in time e una logistica affidabile, ma siamo anche partner di progetto, innovativo e versatile per professionisti e mondo corporate, fornendo un supporto completo in ogni fase del processo. Mettiamo al centro il benessere delle persone, perché questa è la vera evoluzione dello spazio lavoro.

La nostra impronta green, per il pianeta e per le future generazioni, passa anche attraverso l'utilizzo di materie prime rinnovabili, investimento continuo in certificazioni aziendali e di prodotto, controllo della qualità delle materie prime e dell'aria. Oggi siamo una duplice identità pronta a riscrivere le regole con un nuovo modello di business.

From hybrid work to constantly evolving reality: DVO renews itself, revealing a dual soul. A project within a project. From service design to the complete management of the global order or special project.

We are a service company that responds to every creative idea with sustainable products, a just-in-time service and reliable logistics, but we are also an innovative and versatile project partner for professionals and companies, providing comprehensive support at every stage of the process. We put people's well-being at the centre, because this is the true evolution of the workspace.

Our green thinking, for the planet and for future generations, goes also through the use of renewable raw materials, continuous investment in company and product certifications, quality control of raw materials and air. Today we are a twofold identity ready to rewrite the rules with a new model of business.

# Fluid design

Equilibrio | Essenza umana | Inclusività | Natura | Fluidità |  
Movimento | Design flessibile | Diversità | Benessere assoluto |  
Smart living | Talento interiore | Evoluzione

Lavoro agile, libertà di integrare vita e lavoro, equilibrio e talento interiore. Il nuovo ufficio abbraccia l'essenza umana, diventando uno spazio privo di confini, disegnato per il benessere assoluto. Il design flessibile spinge verso ambienti rilassanti, stimolando la creatività e riducendo lo stress.

L'innovazione digitale amplifica questo viaggio, consentendo la scelta del luogo e dell'orario di lavoro. La diversità diventa inclusività, una contaminazione culturale e un nomadismo positivo che arricchiscono le possibilità, disegnando strade verso nuove prospettive, luoghi e volti.

L'evoluzione dell'ufficio crea spazi ibridi in continuo movimento, plasmati per soddisfare le esigenze mutevoli e per incentivare il dialogo con gli altri. L'armonia e la rigenerazione emergono dal bilanciamento di un'esistenza consapevole: uno stile di vita intelligente che grazie alla tecnologia crea un equilibrio responsabile, una connessione e una fluidità positiva tra lavoro e natura.

Balance | Human essence | Inclusivity | Nature | Fluidity |  
Movement | Flexible design | Diversity | Absolute well-being |  
Smart living | Inner talent | Evolution

Agile working, freedom to integrate life and work, balance and inner talent. The new workplace embraces the human essence, becoming a boundless space designed for absolute well-being. The flexible design pushes towards relaxing environments, stimulating creativity and reducing stress.

Digital innovation amplifies this journey, allowing the choice of place and working time. Diversity becomes inclusivity, cultural contamination and positive nomadism enriching possibilities, drawing roads to new perspectives, places and faces.

The evolution of the office creates hybrid spaces in constant movement, shaped to meet changing needs and to encourage dialogue. Harmony and regeneration emerge from the balance of conscious living: a smart living to create a responsible balance, connections and positive fluidity between work and nature.

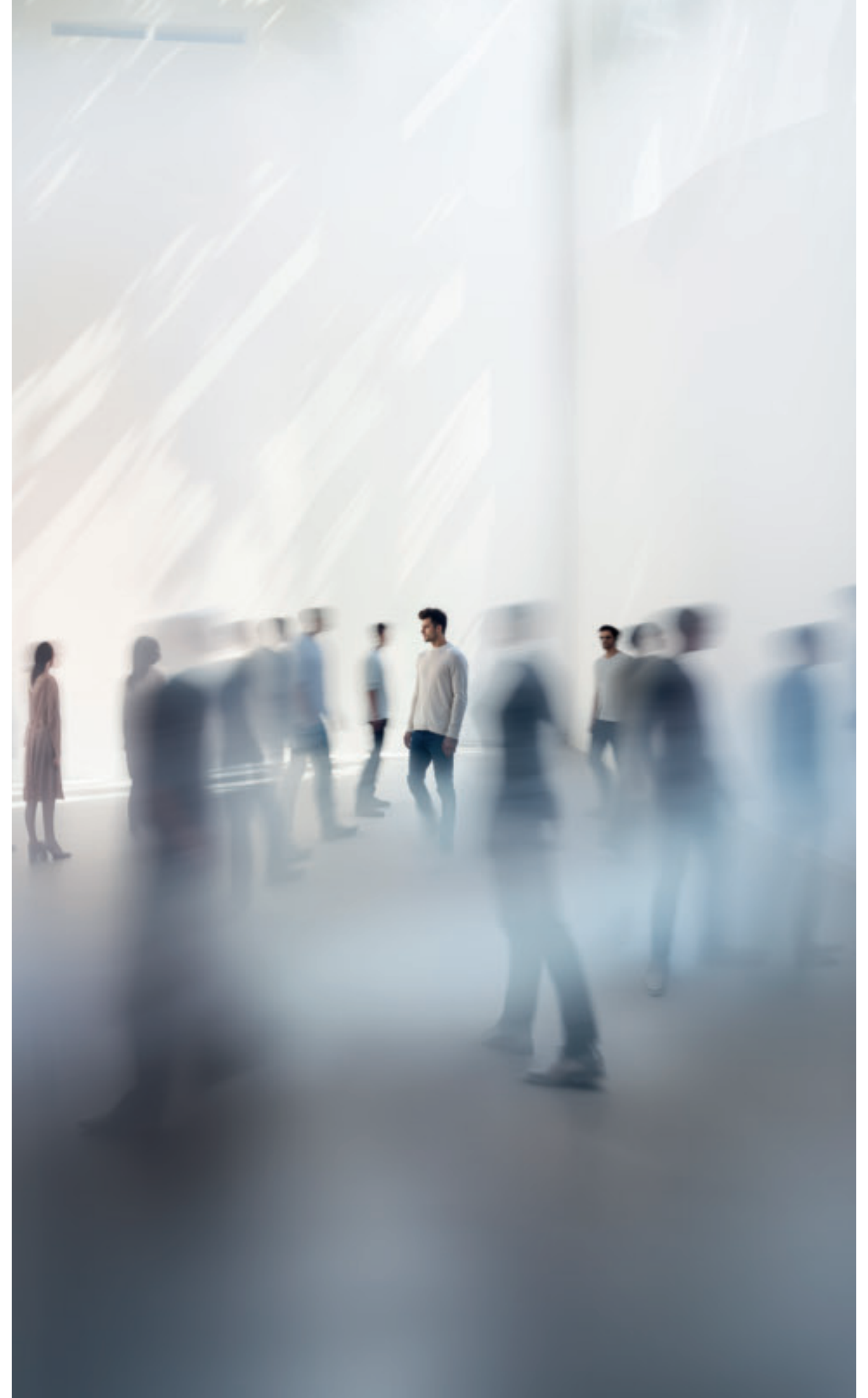



## Rocks Executives

Archetipo di solidità e resistenza, la roccia è l'elemento naturale perfetto per accompagnare il racconto del catalogo Executives. La sua presenza, statuaria e monolitica per definizione, innesca un dialogo con lo spazio circostante connotandone prestigio ed esclusività.

An archetype of solidity and resistance, the rock is the perfect natural element to accompany the narrative of the executives catalogue. Its presence, sculptural and monolithic by definition, triggers a dialogue with the surrounding space, characterising prestige and exclusivity.

Indice  
Index

---

Executives	VIGO DV913	p. 10
	NOTO DV911	p. 38
	RYM DV905	p. 56
	VERTIGO DV901	p. 72
	PLANETA DV902	p. 92
	DAKAR DV914	p. 108
	OXFORD DV910	p. 128

---

Specifiche tecniche Technical Sheets		p. 156
---	--	--------



# VIGO

DV913

DV913-Vigo è un sistema d'arredo direzionale concepito per conferire personalità allo spazio ufficio, un habitat professionale all'insegna della tecnologia e del comfort, flessibile e aperto agli spazi condivisi. Nella concezione di ufficio direzionale, la scrivania DV913-Vigo è un'opera d'architettura in scala ridotta, minuzioso elemento di design in cui gli importanti spessori e finiture materiche caratterizzano i piani di lavoro. Le strutture delle scrivanie mettono in evidenza la particolare composizione tra la gamba portante e il telaio in alluminio. Il contrasto scultoreo di pesi e di volumi identifica a pieno lo spirito che anima la collezione DV913-Vigo.

DV913-Vigo is an executive furniture system designed to give distinctive personality to the office space, a professional environment under the banner of technology and comfort, flexible and ideal for open spaces. In the executive office concept, the DV913-Vigo desk is a small-scale work of architecture, a minimalist design element where the significant thicknesses and material finishes characterize the worktops. The desk structures highlight the special design between the leg and the aluminum frame. The contrast between weights and volumes fully identifies the spirit that drives the DV913-Vigo collection.





Scrivania con penisola sx L 285 P 130 cm  
Piano scrivania: melaminico rovere scuro sp. 50 mm  
Gambe pannellate: melaminico nero opaco soft touch L 10 cm  
Struttura: in estruso di alluminio verniciato antracite  
Desk with 1h round extension W 285 D 130 cm  
Worktop: th. 50 mm dark oak finish melamine  
Panelled legs: matt black soft touch finish melamine W 10 cm  
Frame: extruded aluminium painted anthracite



La struttura è composta da un profilo rettangolare in estruso di alluminio W 100 H 20 mm e una trave canalizzabile.

Executives  
DV913 - VIGO

The structure is composed of a rectangular aluminum extruded profile W 100 H 20 mm and a channelized beam.

Executive chair: Of Course



La gamba pannellata è dotata di un vano verticale per il passaggio dei cavi, che può essere ispezionato tramite un carter amovibile.

The paneled leg has a vertical compartment for cable routing, which can be inspected via a removable cover.



Executives  
DV913 - VIGO



Scrivania L 220 P 220 cm con allungo laterale sx a giorno  
Piano scrivania lato visitatore: melaminico noce sp. 60 mm  
Piano scrivania superiore lato operatore e piano allungo: in vetro  
temprato serigrafato sp. 10 mm bianco, con superficie acidata  
Struttura: in estruso di alluminio verniciato alluminio  
Desk W 220 D 220 cm with left open lateral return  
Visitor-side worktop: th. 60 mm walnut finish melamine  
Upper worktop of operator side and lateral return: th. 10 mm  
white screen-printed tempered glass with etched surface  
Frame: extruded aluminium painted aluminium





Il top-access è rivestito nella stessa finitura del piano scrivania  
in melaminico oppure in vetro serigrafato (bianco o nero).  
The top-access is available in the same finish as the melamine  
Desktop or in screen-printed glass (white or black).

Executives  
DV913 - VIGO



Tavolo riunioni L 240 P 120 cm  
Piano: melaminico noce sp. 50 mm  
Struttura: in estruso di alluminio verniciato alluminio  
Meeting table W 240 D 120 cm  
Top: th. 50 mm walnut finish melamine  
Frame: extruded aluminium painted aluminium

Libreria con ante a ribalta L 215 H 158 P 45 cm  
Scocca: melaminico noce sp. 50 mm  
Schiena e ante: melaminico noce sp. 18 mm  
Bookcase with folding doors W 215 H 158 D 45 cm  
Structure: th. 50 mm walnut finish melamine  
Backpanel and doors: th. 18 mm walnut finish melamine

Executives  
DV913 - VIGO



Le ante a ribalta sono dotate di cerniere metalliche e meccanismo di apertura con sistema di regolazione. Sistema di apertura push-pull con blocco magnetico.

The folding doors are equipped with metal hinges and opening mechanism with adjustment system. Push-pull opening system with magnetic lock.



Scrivania L 220 P 220 cm con allungo dx  
Piano scrivania: melaminico sp. 50 mm rovere chiaro  
Struttura: in estruso di alluminio verniciato bianco  
Desk W 220 D 220 cm with right lateral extension  
Worktop: th. 50 mm Light oak finish melamine  
Frame: extruded aluminium painted white

Executives  
DV913 - VIGO





Tavolo riunioni - Ø 140 cm  
Piano: melaminico sp. 50 mm rovere chiaro  
Struttura: in estruso di alluminio verniciato bianco

Meeting table - Ø 140 cm  
Top: th. 50 mm light oak finish melamine  
Frame: extruded aluminium painted white

Executives  
DV913 - VIGO

Executive chair: Of Course





Scrivania L 285 P 220 cm con allungo laterale sx e penisola dx  
Piano scrivania lato visitatore: melaminico noce sp. 60 mm  
Piano scrivania superiore lato operatore e piano allungo:  
in vetro temprato serigrafato sp. 10 mm nero, con superficie acidata  
Struttura: in estruso di alluminio verniciato antracite  
Desk W 285 D 220 cm with left lateral return and right round extension  
Visitor-side worktop: th. 60 mm walnut finish melamine  
Upper worktop of operator side and lateral return:  
th. 10 mm black screen-printed tempered glass with etched surface  
Frame: extruded aluminium painted anthracite





Cassettiera per allungo a giorno  
Cassetti in melaminico rivestiti in PVC grigio chiaro  
dotati di guide metalliche telescopiche ad estrazione totale con sistema push-pull.  
Il cassetto può essere integrato di telaio portacartelle

Pedestal for open lateral return  
Light grey PVC-coated melamine drawers  
equipped with full-extension telescopic metal glides with push-pull system.  
Drawer can be integrated with file frame



Tavolo riunioni L 240 P 120 cm  
Piano: melaminico sp. 50 mm noce  
Struttura: in estruso di alluminio verniciato antracite  
Meeting table W 240 D 120 cm  
Top: th. 50 mm walnut finish melamine  
Frame: extruded aluminium painted anthracite



Libreria con ante a ribalta L 215 H 158 P 45 cm  
Scocca: melaminico sp. 50 mm noce  
Schiena e ante: melaminico sp. 18 mm nero opaco soft touch  
Bookcase with folding doors W 215 H 158 D 45 cm  
Structure: th. 50 mm Walnut finish melamine  
Back and doors: th. 18 mm matt black soft touch finish melamine

Executives  
DV913 - VIGO





Design  
ENZO BERTI

# NOTO

DV911

L'idea di ambiente direzionale esce dai confini convenzionali dell'ufficio: non è più solo uno spazio lavorativo ma diventa un elegante palcoscenico in cui descrivere strategie di successo. La collezione DV911-Noto riprende l'idea del classico tavolo da lavoro su cavalletto. Tutto è realizzato con materiali naturali, vetro e legno, rivisitati per adattarsi sia allo spazio ufficio che in un elegante ambiente domestico. La struttura è in legno massello, noce canaletto o frassino verniciato antracite, mentre il piano è in vetro per uno stile leggero e minimale. La scrivania DV911-Noto è disponibile sia nella versione con piano rettangolare che semi-circolare. Un tavolo versatile dunque, le cui linee curve e spessori riprendono il meglio dell'artigianalità e ne preservano la contemporaneità.

The idea of the executive environment moves beyond the conventional boundaries of the office: it is no longer just a workspace but becomes an elegant stage on which to describe successful strategies. The DV911-Noto collection takes up the idea of the classic trestle work table. Everything is made of natural materials, glass and wood, revisited to fit both the office space and an elegant home environment. The frame is made of solid wood, "canaletto" walnut or anthracite painted ash, while the top is made of glass for a light and minimal style. The DV911-Noto desk top is available both with rectangular and with semi-circular shape. A versatile table whose curved lines and thicknesses take the best of craftsmanship and preserve its contemporary feel.



Scrivania L 200 P 100 cm  
Piano scrivania: vetro temprato sp. 12 mm,  
con bordi perimetrali lavorati a filo lucido. Finitura fumé  
Gambe e travi: realizzate in legno massello  
noce canaletto verniciato trasparente  
Desk W 200 D 100 cm  
Worktop: th. 12 mm tempered glass worktop  
with outer polished edges. Smocked grey finish  
Legs and beams: made of solid wood  
walnut canaletto varnished transparent



Il traverso della gamba è impreziosito da 2 coperture in acciaio satinato fissate con calamite.  
The leg beam is enriched with 2 satin-finished steel covers fixed with magnets.

Executives  
DV911 - NOTO

Executive chair: Why Not



Tavolo riunioni L 240 P 120 cm  
Piano: vetro temprato sp. 12 mm, con bordi perimetrali lavorati a filo lucido. Finitura fumé  
Gambe e travi: realizzate in legno massello noce canaletto verniciato trasparente  
Meeting table W 240 D 120 cm  
Top: 12 mm tempered glass worktop with outer polished edges. Smocked grey finish  
Legs and beams: made of solid wood, canaletto walnut finish, transparently varnished



I piani sono dotati di ghiera in zama incollate al piano.  
Il fissaggio del piano alle travi ed alla gamba avviene mediante viti.  
The tops are fitted with zamak rings glued to the top.  
The top is fastened to the beams and the leg by means of screws.

Executives  
DV911 - NOTO





Tavolo riunioni - Ø 140 cm  
Piano: vetro temprato sp. 12 mm, con bordi perimetrali lavorati a filo lucido. Finitura fumé  
Gambe e travi: realizzate in frassino verniciato antracite a poro aperto  
Meeting table - Ø 140 cm  
Top: 12 mm tempered glass worktop with outer polished edges. Smoked grey finish  
Legs and beams: made of anthracite open-pore varnished ash wood

Contenitori di servizio, madie e pensili DV504-Milo  
Strutture: melaminico grafite soft touch  
Ante: melaminico verde opaco soft touch  
Service cabinets, cabinets and wall units DV504-Milo  
Structures: graphite soft touch finish melamine  
Doors: matt green soft touch finish melamine

Executives  
DV911 - NOTO



Scrivania L 200 P 100 cm  
Piano scrivania: vetro temprato sp. 12 mm,  
con bordi perimetrali lavorati a filo lucido. Finitura fumé  
Gambe e travi: realizzate in frassino verniciato antracite a poro aperto  
Mobile di servizio DV504-Milo

Desk W 200 D 100 cm  
Worktop: 12 mm tempered glass worktop  
with outer polished edges. Smocked grey finish  
Legs and beams: made of anthracite open-pore varnished ash wood  
Service cabinet DV504-Milo





Scrivania L 178 P 149 cm  
Piano scrivania: vetro temprato sp. 12 mm, con bordi perimetrali lavorati a filo lucido. Finitura trasparente  
Gambe e travi: realizzate in legno massello noce canaletto verniciato trasparente  
Mobile di servizio DV504-Milo  
Desk W 178 D 149 cm  
Worktop: 12 mm tempered glass worktop with outer polished edges. Transparent finish  
Legs and beams: made of solid wood, canaletto walnut finish, transparently varnished  
Service cabinet DV504-Milo



Executive chair: Why Not

Executives  
DV911 - NOTO



Tavolo riunioni L 240 P 120 cm  
Piano: vetro temprato sp. 12 mm,  
con bordi perimetrali lavorati a filo lucido. Finitura trasparente  
Gambe e travi: realizzate in legno massello noce canaletto verniciato trasparente  
Meeting table W 240 D 120 cm  
Top: 12 mm tempered glass worktop with outer polished edges. Transparent finish  
Legs and beams: made of solid wood, canaletto walnut finish, transparently varnished



Gamba in legno massello a sezione rotonda diam. 63 mm  
Round solid wood leg diam. 63 mm

Executives  
DV911 - NOTO





Design  
ANTONIO MORELLO

# RYM

DV905

Il tavolo DV905-Rym rappresenta la perfetta combinazione tra design minimalista e innovazione tecnologica, unendo eleganza e funzionalità. Le ampie superfici, lo stile essenziale e la cura dei dettagli esprimono l'anima di questa collezione.

La struttura in estruso di alluminio, apparentemente sottile ma resistente, si adatta a diversi ambienti e stili di arredamento garantendo una stabilità impeccabile.

La tecnologia "nascosta" all'interno del piano consente di ottenere tavoli di grandi dimensioni senza l'impiego di elementi strutturali intermedi garantendo pulizia formale e leggerezza.

Il piano di spessore 50 mm, è composto da un telaio perimetrale esterno e rinforzato da un telaio perimetrale interno. Il tavolo DV905-Rym è disponibile in diverse misure e colori per soddisfare le diverse esigenze progettuali.

The DV905-Rym table represents the union of minimalist design and technological innovation, combining elegance and functionality.

The large surfaces, essential style and attention to detail express the soul of this collection.

The minimal but strong aluminum structure adapts to different environments and furnishing styles, ensuring impeccable stability.

The "hidden" technology inside the top makes it possible to produce large dimensions tables without the use of intermediate structural elements ensuring a light look.

The 50 mm thick top is composed of an outer perimeter frame reinforced by an inner perimeter frame. The DV905-Rym table is available in different sizes and colours to meet the different design requirements.

Scrivania L 220 P 100 cm con allungo dx L 120 P 60 cm  
Piano scrivania: realizzato con pannello ligneo sp. 50 mm  
rivestito in laminato rovere scuro sp. 0.5 mm  
Struttura: in alluminio finitura brill

Desk W 220 D 100 cm with right lateral return W 120 D 60 cm  
Worktop: made of 50 mm thick wooden panel coated  
with 0.5 mm thick dark oak laminate  
Structure: "brill" polished aluminium



Profilo perimetrale in alluminio estruso disponibile in finitura bianco, alluminio brill o antracite  
Extruded aluminum perimeter profile available in white, brill aluminum or anthracite finish

Executives  
DV905 - RYM







Tavolo riunioni L 300 P 120 cm  
Piano: realizzato con pannello ligneo sp. 50 mm  
rivestito in laminatino bianco sp. 0.5 mm  
Struttura: in alluminio finitura bianco  
Meeting table W 300 D 120 cm  
Top: made th. 50 mm wooden panel coated  
with th. 0.5 mm white laminate  
Structure: white finish aluminum



Scrivania L 220 P 100 cm  
Piano scrivania: realizzato con pannello ligneo  
sp. 50 mm rivestito in laminatino bianco sp. 0.5 mm  
Struttura: in alluminio finitura bianco

Executives  
DV905 - RYM

Meeting table W 220 D 100 cm  
Worktop: made of th. 50 mm wooden panel  
coated with th. 0.5 mm white laminate  
Structure: white finish aluminum

Executive chair: Vega



Tavolo riunioni L 160 P 160 cm  
Piano: realizzato con pannello ligneo sp. 50 mm  
rivestito in laminatino rovere chiaro sp. 0.5 mm  
Struttura: in alluminio finitura bianco  
Meeting table W 160 D 160 cm  
Top: made of th. 50 mm wooden panel coated  
with th. 0.5 mm light oak laminate  
Structure: white finish aluminum

Executive chair: Vega



Scrivania L 220 P 100 cm  
Piano scrivania: realizzato con pannello ligneo sp. 50 mm  
rivestito in laminato rovere chiaro sp. 0.5 mm  
Struttura: in alluminio finitura bianco  
Mobile di servizio: melaminico bianco

Desk W 220 D 100 cm  
Worktop: made of th. 50 mm wooden panel coated  
with th. 0.5 mm light oak laminate  
Structure: white finish aluminum  
Service cabinet: white finish melamine

Executives  
DV905 - RYM



In opzione: canalina verticale in metallo per passaggio cavi.  
Optional: vertical metal cable duct.

Executives  
DV905 - RYM



Tavolo riunioni L 400 P 120 cm  
Piano: realizzato con pannello ligneo sp. 50 mm rivestito  
in laminatino nero sp. 0.5 mm  
Struttura: in alluminio finitura nero  
Meeting table W 400 D 120 cm  
Top: made of th. 50 mm wooden panel coated  
with th. 0.5 mm black laminate  
Structure: black finish aluminum

Executives  
DV905 - RYM



Design  
ANTONIO MORELLO

# VERTIGO

DV901

Le scrivanie DV901-Vertigo superano l'idea di scrivania tradizionale e rispondono ad un nuovo approccio di ambiente rappresentativo e funzionale. DV901-Vertigo è un tavolo caratterizzato da una solida struttura in pressofusione di alluminio a sezione trapezoidale e dall'originale design del giunto in pressofusione di zama che unisce, con equilibrio, il linguaggio tecnico-industriale a quello decorativo, dando vita ad un prodotto modulare e funzionale. Le gambe sono disponibili in due diverse tipologie: con base o senza base. Una collezione che possiede un forte grado di comfort e qualità estetica, spaziando dall'ambiente direzionale sino all'area operativa.

DV901-Vertigo desks go beyond the idea of the traditional desk and respond to a new approach of a representative and functional environment. DV901-Vertigo is a table characterized by a die-cast aluminium frame with a trapezoidal cross-section and by the original design of the zamak die-cast joint that combines a technical-industrial and decorative language, creating a modular, functional product. There are two different types of legs: with base or without base. This collection has a great degree of comfort and aesthetic quality, suitable for the executive environment as well as the operative areas.



Tavolo riunioni L 320 P 160 cm  
Piano: melaminico verde opaco soft touch  
Gambe: metallo verniciato verde opaco  
Meeting table W 320 D 160 cm  
Top: matt green soft touch finish melamine  
Legs: matt green painted metal

Executives  
DV901 - VERTIGO

Executive chair: Vega







Scrivania L 200 P 90 con allungo L 120 P 60 cm  
Piano scrivania e modesty panel: melaminico rovere scuro  
Gambe: in alluminio verniciato tortora

Desk W 200 D 90 with return W 120 D 60 cm  
Worktop and modesty panel: dark oak finish melamine  
Legs: painted taupe-coloured aluminium



La gamba è realizzata con montanti in estruso di alluminio di sezione triangolare 75x75 mm.  
The leg is made of extruded aluminium uprights with a 75x75 mm triangular cross-section.

Executives  
DV901 - VERTIGO





Scrivania L 200 P 90  
Piano scrivania e modesty panel: melaminico bianco  
Gambe: in alluminio verniciato  
Desk W 200 D 90  
Worktop and modesty panel: white finish melamine  
Legs: in painted aluminium



Giunti angolari di collegamento e piedini fissi realizzati  
in pressofusione di zama, cromati oppure verniciati.

Connecting corner joints and fixed feet made  
of die-cast zamak, chrome-plated or painted.

Executives  
DV901 - VERTIGO



Tavolo riunioni L 280 P 140 cm  
Piano: melaminico bianco soft touch  
Gambe: in alluminio verniciato bianco  
Meeting table W 280 D 140 cm  
Top: matt white soft touch finish melamine  
Legs: painted white-coloured aluminium

Executives  
DV901 - VERTIGO

Executive chair: Vega



Tavolo riunioni modulare L 280 P 136.5 cm  
Piano: melaminico bianco  
Gambe: massello impiallacciato in rovere naturale - metallo verniciato bianco  
Modular meeting table W 280 D 136.5 cm  
Top: white finish melamine  
Legs: solid wood veneered with natural oak - white painted metal

Executives  
DV901 - VERTIGO



Scrivania L 200 P 90 cm  
Piano scrivania: melaminico noce  
Gambe: in alluminio verniciato bianco  
Mobile di servizio: melaminico bianco  
Desk W 200 D 90 cm  
Worktop: walnut finish melamine  
Legs: painted white-coloured aluminium  
Service cabinet: white finish melamine



Scrivania L 160 P 160 cm  
Piano scrivania: melaminico noce  
Gambe: in alluminio verniciato bianco  
Mobile di servizio: melaminico bianco  
Desk W 160 D 160 cm  
Worktop: walnut finish melamine  
Legs: painted white-coloured aluminium  
Service cabinet: white finish melamine

Executives  
DV901 - VERTIGO

Executive chair: Vega





Design  
ANTONINO D'AGOSTINO

# PLANETA

DV902

La collezione DV902-Planeta riflette l'evoluzione della scrivania manageriale. Una linea direzionale elegante e minimale che si distingue attraverso il mobile di servizio che funge da struttura portante al tavolo oltre che elemento di archiviazione.

Il piano di lavoro è compatto e solido con la struttura. Sotto il piano di lavoro è presente un telaio perimetrale realizzato con estrusi di alluminio a sezione trapezoidale. La gamba ad anello, quale segno distintivo dell'intera collezione, è costituita da una cornice rettangolare di acciaio e nella parte superiore esterna della gamba è applicato un carter in lamiera piegata che conferisce originalità estetica. La varietà delle finiture rendono DV902-Planeta una scelta versatile e perfetta per chi cerca una scrivania manageriale progettata per durare nel tempo.

The DV902-Planeta collection reflects the evolution of the managerial desk. An elegant and minimal executive line that is distinguished through the service cabinet that serves as a supporting structure to the desk as well as a storage element.

The table top is solid with the structure. Under the worktop there is a perimeter frame made from trapezoidal-section made from extruded aluminium. The ring leg, as the feature of the entire collection, consists of a rectangular steel frame and a folded metal carter applied to the upper outer part of the leg, giving it aesthetic originality. The variety of finishes makes DV902-Planeta a versatile and the perfect choice for those seeking a managerial desk designed to last.





Tavolo riunioni L 160 P 160 cm  
Piano: melaminico grafite soft touch  
Gambe: metallo verniciato tortora  
Meeting table W 160 D 160 cm  
Top: graphite soft touch finish melamine  
Legs: taupe painted metal

Executive chair: Vega



Scrivania L 200 P 90 cm  
Piano scrivania: melaminico grafite soft touch  
Gambe: metallo verniciato tortora  
Mobile di servizio: melaminico tortora soft touch  
Desk W 200 D 90 cm  
Worktop: graphite soft touch finish melamine  
Legs: taupe painted metal  
Service cabinet: taupe soft touch finish melamine

Executives  
DV902 - PLANETA



Scrivania L 200 P 90 cm  
Piano scrivania: melaminico rovere chiaro  
Gambe: metallo verniciato bianco  
Mobile di servizio: melaminico bianco  
Ante scorrevoli: melaminico rovere chiaro  
Desk W 200 D 90 cm  
Worktop: light oak finish melamine  
Legs: white painted metal  
Service cabinet: white finish melamine  
Sliding doors: light oak finish melamine

Executives  
DV902 - PLANETA



Tavolo riunioni L 240 P 120 cm  
Piano: melaminico rovere chiaro  
Gambe: metallo verniciato bianco  
Meeting table W 240 D 120 cm  
Top: light oak finish melamine  
Legs: white painted metal



Scrivania L 180 P 90 cm  
Piano scrivania: melaminico bianco  
Gambe: metallo verniciato bianco  
Mobile di servizio: melaminico bianco  
Desk W 180 D 90 cm  
Worktop: white finish melamine  
Legs: white painted metal  
Service cabinet: white finish melamine



Executives  
DV902 - PLANETA



Scrivania L 200 P 90 cm integrabile con il mobile di servizio  
Piano scrivania: melaminico rovere scuro  
Gambe pannellate: melaminico rovere scuro con profilo metallo verniciato grafite  
Mobile di servizio: melaminico rovere scuro  
Desk W 200 D 90 cm to be connected to the service cabinet  
Worktop: dark oak finish melamine  
Panelled legs: dark oak melamine with graphite painted metal frame  
Service cabinet: dark oak finish melamine

A sinistra: contenitori DV504-Milo.  
Left: DV504-Milo storage units.

Executives  
DV902 - PLANETA



Executive chair: Vega



Il mobile di servizio consente l'accesso alla gestione dei cablaggi.  
The service cabinet allows access to wiring management.

Executives  
DV902 - PLANETA





Design  
ANTONIO MORELLO

# DAKAR

DV914

DV914-Dakar è una moderna scrivania direzionale, dal design aereo, che mira a trasformare lo spazio di lavoro in luogo inclusivo e di interazione. Le scrivanie e i tavoli riunione, abbinati a contenitori di servizio e penisole, consentono di creare spazi manageriali non convenzionali, giocando tra funzioni e cromie. Le forme morbide e affusolate delle gambe coniche identificano i tavoli dell'intera collezione, mentre il dinamismo compositivo e la versatilità cromatica caratterizzano i diversi elementi che possono essere liberamente combinati tra loro.

DV914-Dakar is a modern and light executive desk that aims to transform the workspace into an inclusive place of interaction. The desks and meeting tables, combined with service storage units and peninsula tops, make it possible to create unconventional managerial spaces. The conical shapes of the legs identify the tables of the collection, while the wide range of compositions and colors characterize the various elements which can be freely combined.





Scrivania L 200 P 100  
Piano scrivania e modesty panel: melaminico grafite soft touch  
Gambe: metallo verniciato in finitura cromo  
Desk W 200 D 100  
Worktop and modesty panel: graphite soft touch finish melamine  
Legs: painted metal in chrome finish  
Executive chair: Vega



Tavolo riunioni circolare Ø 120 cm  
Piano: melaminico grafite soft touch sp. 25 mm  
Gambe: metallo verniciato in finitura cromo  
Round meeting table Ø 120 cm  
Top: graphite soft touch finish melamine th. 25 mm  
Legs: painted metal in chrome finish

Executives  
DV914 - DAKAR





Tavolo riunioni L 240 P 120 cm  
Piano: melaminico rovere scuro  
Gambe: metallo verniciato antracite  
Meeting table W 240 D 120 cm  
Top: dark oak finish melamine  
Legs: anthracite painted metal

Executive chair: Vega



Scrivania L 200 P 100 con allungo L 100 P 65 cm  
Piano scrivania e modesty panel: melaminico rovere scuro  
Gambe: metallo verniciato antracite  
Desk W 200 D 100 with return W 100 D 65 cm  
Worktop and modesty panel: dark oak finish melamine  
Legs: anthracite painted metal

Executives  
DV914 - DAKAR





Scrivania L 200 P 100 cm  
Piano scrivania: melaminico tortora soft touch  
Gambe: metallo verniciato bianco  
Mobile di servizio DV504-Milo: melaminico tortora soft touch  
Ante: melaminico bianco  
Desk W 200 D 100 cm  
Worktop: taupe soft touch finish melamine  
Legs: white painted metal  
Service cabinet DV504-Milo: taupe soft touch finish melamine  
Doors: white finish melamine

Scrivania L 160 P 160 cm  
Piano scrivania: melaminico tortora soft touch  
Gambe: metallo verniciato bianco  
Mobile di servizio DV504-Milo: melaminico bianco  
Ante: melaminico tortora soft touch  
Desk W 160 D 160 cm  
Worktop: taupe soft touch finish melamine  
Legs: white painted metal  
Service cabinet DV504-Milo: white finish melamine  
Doors: taupe soft touch finish melamine

Executives  
DV914 - DAKAR



Scrivania L 200 P 100 cm  
Piano scrivania: melaminico rovere naturale  
Gambe: metallo verniciato bianco  
Mobile di servizio DV504-Milo: melaminico rovere naturale  
Ante: melaminico bianco  
Desk W 200 D 100 cm  
Worktop: natural oak finish melamine  
Legs: white painted metal  
Service cabinet DV504-Milo: natural oak finish melamine  
Doors: white finish melamine



Tavolo riunioni L 160 P 160 cm  
Piano: melaminico rovere naturale  
Gambe: metallo verniciato bianco  
Meeting table W 160 D 160 cm  
Top: natural oak finish melamine  
Legs: white painted metal

Executives  
DV914 - DAKAR

Executive chair: Vega



Scrivania L 250 P 125 cm  
Piano scrivania: melaminico noce  
Gambe: metallo verniciato antracite  
Mobile di servizio P 66 cm DV-914 Dakar: melaminico nero soft touch  
Desk W 250 D 125 cm  
Worktop: walnut finish melamine  
Legs: anthracite painted metal  
Service cabinet D 66 cm DV-914 Dakar: matt black soft touch finish melamine

Executives  
DV914 - DAKAR





Mobile di servizio L 180 P 66 DV914-Dakar  
Anta scorrevole: melaminico nero soft touch  
Cassetteria (optional): melaminico noce  
Service cabinet W 180 D 66 cm DV914-Dakar  
Sliding door: matt black soft touch finish melamine  
Pedestal (optional): walnut finish melamine

Executives  
DV914 - DAKAR



# OXFORD

DV910

DV910-Oxford è una collezione executive che nasce da un'approfondita ricerca sull'evoluzione del lavoro contemporaneo. Un elemento d'arredo che genera un'alternanza di pieni e vuoti, rivelando preziosi dettagli funzionali e sofisticati equilibri proporzionali. DV910-Oxford propone scrivanie ad altezza fissa e regolabili in altezza. Il piano principale è formato da elementi rettangolari che giocano con la matericità delle finiture e, per una pulizia formale, possono essere scorrevoli e nascondere il cablaggio. La scrivania può essere corredata di un piano penisola circolare studiato come "guest area". Completano la collezione i contenitori di servizio, i tavoli riunione e l'armadio multifunzione che si presta sia in ambiente ufficio che domestico. Tutti gli elementi sono caratterizzati dallo stesso segno estetico: elementari geometrie basate su linee e forme essenziali che si intersecano tra loro e creano un insieme di grande eleganza.

V910-Oxford is an executive collection born out from in-depth research into the evolution of contemporary work. A piece of furniture that generates an interplay of solids and voids, revealing precious functional details and sophisticated proportional balances. DV910-Oxford offers fixed-height and height-adjustable desks. The main top is formed by rectangular elements that play with the texture of the finishes and, can become sliding tops to hide the cables. The desk can be equipped with a round peninsula top designed for the "guests area". The collection is completed by service storage units, meeting tables and a multifunctional cabinet that is suitable for both office and home environments. All the elements are characterized by the same aesthetic sign: elementary geometries based on essential lines and shapes that intersect with each other and create a set of great elegance.



Scrivania con mobile di servizio L 230 P 210 cm  
Piano scrivania operatore e modesty panel:  
melaminico nocciola effetto "pelle"  
Piano scrivania visitatore: melaminico bianco  
Gambe pannellate: melaminico bianco  
Desk with service cabinet W 230 D 210 cm  
Operator worktop and modesty panel:  
'leather' effect hazelnut finish melamine  
Visitor side desktop: white finish melamine  
Panelled legs: white finish melamine



Piano scrivania scorrevole per una perfetta gestione dei cavi.  
Sliding worktop for a perfect cable management.

Executives  
DV910 - OXFORD

Executive chair: Of Course



Mobile di servizio con anta scorrevole e serratura centralizzata;  
cassetto in metallo con serratura (optional).  
Service cabinet with sliding door and central lock;  
metal drawer with lock (optional).



Sportello superiore apribile  
Il mobile è fornito di un portaprese  
fissato alla schiena interna.  
Opening upper door  
The service cabinet is equipped with a  
socket holder fixed to the internal back panel.



Tavolo riunioni L 240 P 120 cm  
Piano: melaminico bianco sp. 38 mm  
Gambe pannellate: melaminico bianco  
Top access: optional  
Meeting table W 240 D 120 cm  
Top: white finish melamine th. 38 mm  
Panelled legs: white finish melamine  
Top access: optional

Il layout delle pareti in vetro è a solo scopo illustrativo.  
The glass wall partition layout is for illustrative purposes only.

Executives  
DV910 - OXFORD



Il layout delle pareti in vetro è a solo scopo illustrativo.  
The glass wall partition layout is for illustrative purposes only.

Scrivania L 220 P 214 cm con mobile di servizio.  
Regolazione elettrica in altezza a tre stadi (75÷141 cm)  
Piano scrivania operatore e modesty panel:  
melaminico cappuccino effetto "pelle"  
Piano scrivania visitatore: melaminico noce  
Gambe pannellate: melaminico noce  
Sit stand desk W 220 D 214 cm with service cabinet.  
Electric three-stage height adjustment (H 75÷141 cm)  
Operator worktop and modesty panel:  
'leather' effect cappuccino finish melamine  
Visitor side desktop: walnut finish melamine  
Panelled legs: walnut finish melamine

Executives  
DV910 - OXFORD





Tavolo riunioni L 240 P 120 cm  
Piano: melaminico sp. 38 mm noce  
Gambe pannellate: melaminico noce  
Top access: optional  
Meeting table W 240 D 120 cm  
Top: walnut finish melamine th. 38 mm  
Panelled legs: walnut finish melamine  
Top access: optional

Executives  
DV910 - OXFORD





Scrivania L 220 P 90 cm. Regolazione elettrica in altezza a tre stadi (75÷141 cm)  
Piano scrivania operatore e modesty panel: melaminico rovere naturale  
Piano scrivania visitatore: melaminico bianco  
Gamba pannellata ispezionabile: melaminico bianco  
Sit stand desk W 220 D 90 cm. Electric three-stage height adjustment (H 75÷141 cm)  
Operator worktop and modesty panel: natural oak finish melamine  
Visitor side desktop: white finish melamine  
Panel leg with an opening casing: white melamine



Tastierino per regolazione altezza piano con 4 memorie  
Gamba pannellata ispezionabile: melaminico bianco.  
Control pad with 4 memories for height adjustable worktop  
Panel leg with an opening casing: white melamine.



Executives  
DV910 - OXFORD

Scrivania L 224 P 90 cm - (Lunghezze disponibili L 184 - 204 - 224 cm)  
Piano scrivania operatore e modesty panel: melaminico rovere naturale  
Piano scrivania visitatore: melaminico bianco  
Desk W 224 D 90 cm - (Available lengths W 184 - 204 - 224 cm)  
Operator worktop and modesty panel: natural oak finish melamine  
Visitor side desktop: white finish melamine

Executives  
DV910 - OXFORD

Executive chair: Of Course





Contenitore multifunzione L 250 P 60 H 190 cm  
cassettiera/schiena puntinabile/barra Led (optional)  
Multi-purpose storage unit W 250 D 60 H 190 cm  
Carrying pedestal/Pinnable back panel/Led spotlight bar (optionals)

Executives  
DV910 - OXFORD





Scrivania L 200 P 90 cm con gamba rientrante  
Piano scrivania operatore e modesty panel: melaminico rovere chiaro  
Piano scrivania visitatore: melaminico rovere chiaro  
Gamba pannellata: melaminico rovere chiaro  
Desk W 200 D 90 cm with shorter leg than worktop  
Operator worktop and modesty panel: light oak finish melamine  
Visitor side desktop: light oak finish melamine  
Panel leg: light oak finish melamine



Tavolo riunioni L 140 P 140 cm  
Piano: melaminico sp. 38 mm rovere chiaro  
Gambe pannellate: melaminico rovere chiaro  
Top access: optional

Meeting table W 140 D 140 cm  
Top: light oak finish melamine th. 38 mm  
Panelled legs: light oak finish melamine  
Top access: optional

Executive chair: Of Course



Executives  
DV910 - OXFORD



Scrivania con mobile di servizio L 250 P 210 cm con penisola L 120 cm  
Piano scrivania operatore e modesty panel: melaminico nocciola effetto "pelle"  
Piano scrivania visitatore: melaminico rovere scuro  
Gambe pannellate: melaminico rovere scuro  
Desk with service cabinet W 250 D 210 cm with round extension W 120 cm  
Operator worktop and modesty panel: 'leather' effect hazelnut finish melamine  
Visitor side desktop: dark oak finish melamine  
Panelled legs: dark oak finish melamine



Tavolini caffè L 60 P 60 H 45 cm e L 120 P 60 H 45 cm  
melaminico rovere scuro  
Coffee tables W 60 D 60 H 45 cm and W 120 D 60 H 45 cm  
dark oak finish melamine

Executives  
DV910 - OXFORD



## Specifiche Tecniche Technical Sheets

---

Executives	VIGO DV913	p. 158
	NOTO DV911	p. 162
	RYM DV905	p. 166
	VERTIGO DV901	p. 170
	PLANETA DV902	p. 176
	DAKAR DV914	p. 182
	OXFORD DV910	p. 186
	MILO DV504	p. 192

---

Wire Management		p. 197
-----------------	--	--------

---

Plug&Play DV300		p. 204
--------------------	--	--------





DV913 - VIGO  
lato operatore | scrivania con piano sp. 50 mm  
operator side | desk with worktop th. 50 mm



DV913 - VIGO  
lato visitatore | scrivania con piano sp. 60 mm  
visitor side | desk with worktop th. 60 mm



DV913 - VIGO LIBRERIA  
DV913 - VIGO BOOKSHELF

LEGENDA  
LEGEND

**M** Melaminico  
Melamine

**MT** Metallo  
Metal

**V** Vetro  
Glass

\* Non in pronta consegna  
\* Not in prompt delivery

## Finiture Finishes

### Scrivania - Tavoli riunione Desk - Meeting tables

**M** Piani scrivania sp. 50 mm - Modesty panel sp. 30 mm  
Worktops th. 50 mm - Modesty panel th. 30 mm



**V** Piani scrivania supplementari sp. 10 mm in vetro temprato serigrafato, con superficie acidata  
Additional worktops th. 10 mm screen-printed tempered glass with etched surface

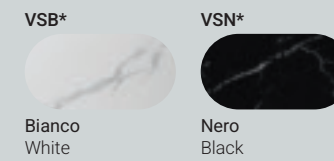

**M** Piani scrivania supplementari sp. 10 mm  
Additional worktops th.10 mm



**MT** Strutture metalliche  
Metal structures

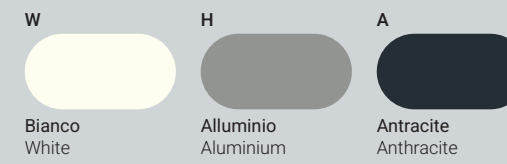

**M** Gambe pannellate sp. 100 mm - Pannelli sp. 18 mm uniti con tecnologia folding  
Panelled legs th. 100 mm - panels th. 18 mm joined using folding technology



### Libreria Bookshelf

**M** Scocche: Coperchio, fondo e ripiani sp.50 mm. Fianchi e divisori sp. 30 mm  
Bodies: Top, bottom and shelves th. 50 mm. Side panels and divider panels th. 30 mm

Ante e schiene sp. 18 mm  
Doors and back panels th. 18 mm

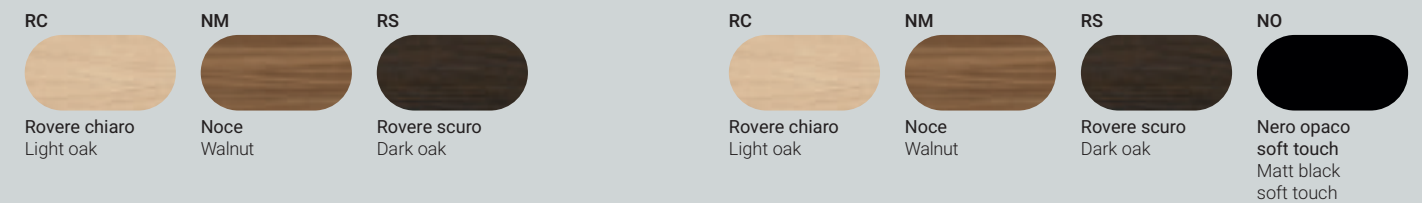

**MT** Strutture metalliche  
Metal structures



Dati tecnici  
Technical data

Scrivanìa  
Desks

Scrivanìa con allungo a giorno  
Desk with open extension

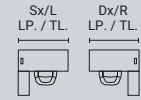
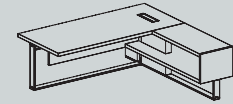

LP/TL 200 | L/W 200 | P/D 220 | H/H 75  
220

Scrivanìa con allungo  
Desk with lateral extension

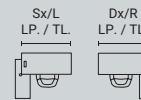
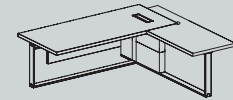

LP/TL 200 | L/W 230 | P/D 220 | H/H 75  
220 250

Scrivanìa con penisola  
Desk with peninsula

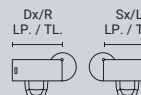
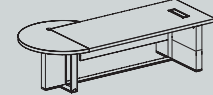

LP/TL 200 | L/W 265 | P/D 130 | H/H 75  
220 285

**V** Scrivanìa con piano e allungo a giorno in vetro  
Desk with glass worktop and open lateral extension

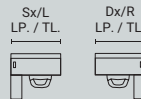
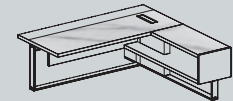

LP/TL 200 | L/W 200 | P/D 220 | H/H 76  
220

**V** Scrivanìa con piano e allungo laterale in vetro  
Desk with glass worktop and lateral extension

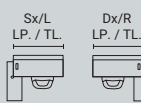
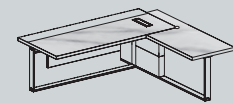

LP/TL 200 | L/W 230 | P/D 220 | H/H 76  
220 250

**V** Scrivanìa con piano e allungo laterale in vetro  
Desk with glass worktop and lateral extension

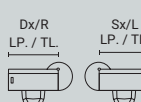
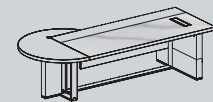

LP/TL 200 | L/W 265 | P/D 130 | H/H 76  
220 285

Penisola  
Peninsula



L/W 130 | P/D 130 | H/H 75

Penisola - per scrivania con piano in vetro  
Peninsula - for desk with glass worktop

L/W 130 | P/D 130 | H/H 76

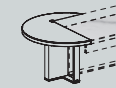

Cassetto per cassettera - Optional  
Drawer for pedestal - Optional

L/W 60 | P/D 50 | H/H 36.5

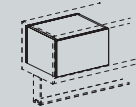

Cassettera per allungo a giorno  
Pedestal for open side extension

L/W 56 | P/D 41 | H/H 11

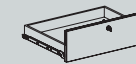

Reggicartella per cassetto  
Folder frame for drawer

L/W 55 | P/D 40 | H/H 8

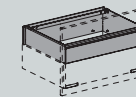

Tavoli riunione  
Meeting tables

Tavolo riunioni - Ø 140  
Meeting table - Ø 140

L/W 140 | P/D 140 | H/H 75



Tavolo riunioni - P 120  
Meeting table - D 120

L/W 240 | P/D 120 | H/H 75

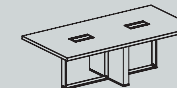

Libreria con ante a ribalta  
Bookcase with flap doors

L/W 215 | P/D 45 | H/H 158

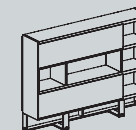

- M** Melaminico  
Melamine
- V** Vetro  
Glass

Dimensioni espresse in centimetri  
Dimensions stated in centimetres



DV911 - NOTO

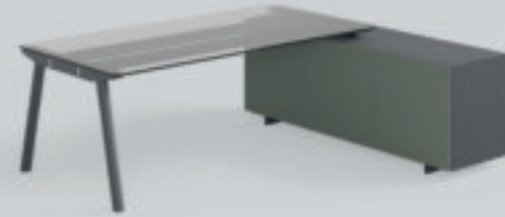

DV911 - NOTO  
lato operatore  
operator side

## Finiture Finishes

### Scrivania Desk

**V** Piani scrivania sp. 12 mm in vetro con bordi lucidi lavorati a filo  
Glass worktops th. 12 mm with polished edges

**VTR**

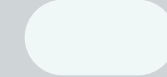

Vetro trasparente  
Transparent glass

**VF**



Vetro fumè  
Smoked grey glass

**M** Modesty panel in melaminico sp. 18 mm  
Melamine modesty panel th. 18 mm

**WN**



Bianco  
White

**NM**



Noce  
Walnut

**NO\***



Nero opaco  
soft touch  
Matt black  
soft touch

**W** Gambe e travi in legno  
Wooden legs and beams

**ENC**



legno massello  
noce canaletto  
verniciato  
trasparente  
solid wood of  
Canaletto walnut,  
transparent  
painted

**EAN**



Frassino  
verniciato  
antracite  
a poro aperto  
open pore  
anthracite -  
coated  
ash finish

### LEGENDA LEGEND

**M** Melaminico  
Melamine

**W** Legno  
Wood

**V** Vetro  
Glass

\* Non in pronta consegna  
\* Not in prompt delivery

Per finiture e altri contenitori DV504 - Milo consultare pagine 192 - 193  
See pages 192 - 193 for finishes and others DV504 - Milo storages

Dati tecnici  
Technical data

Scrivania  
Desk

Scrivanie P 60 - P 90 - P 100  
D 60 - D 90 - D 100 desks

L/W	200	P/D	60	H/H	74
	180		90		
	200		100		



Integrabile su moduli base DV504-Milo  
For integration with DV504-Milo base modules

L/W	200	P/D	60	H/H	74
	180		90		
	200		100		

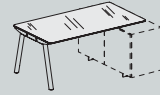

Modesty panel - Per scrivanie P 90-100  
Modesty panels - For desks D 90-100

LP/TL	180	L/W	127	P/D	1.8	H/H	30
	200		147				



Modesty panel - Per tavolo semi-tondo P 149  
Modesty panel - For semi-round table D 149

L/W	76	P/D	1.8	H/H	30
-----	----	-----	-----	-----	----

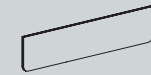

Tavoli riunione  
Meeting tables

Tavolo riunioni - P 120  
Meeting table - D 120

L/W	240	P/D	120	H/H	74
-----	-----	-----	-----	-----	----

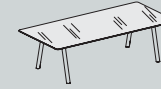

Tavolo riunioni - Ø 140  
Meeting table - Ø 140

L/W	140	P/D	140	H/H	74
-----	-----	-----	-----	-----	----



Tavolo riunioni - P 149  
Meeting table - D 149

L/W	178	P/D	149	H/H	74
-----	-----	-----	-----	-----	----



Canalina passacavi verticale  
Canale passacavi verticale

H/H	58
-----	----

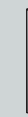

M Melaminico  
Melamine

W Legno  
Wood

V Vetro  
Glass

Dimensioni espresse in centimetri  
Dimensions stated in centimetres

Per finiture e altri contenitori DV504-Milo consultare pagine 192 - 193  
See pages 192 - 193 for finishes and others DV504-Milo storages



DV905 - RYM



DV905 - RYM  
lato operatore  
operator side

## Finiture Finishes

### Scrivania Desk

- L** Piani scrivania sp. 50 mm realizzati con pannello ligneo e con rivestimento in laminatino sp. 0.5 mm  
Worktops manufactured with th. 50 mm and wood panel with th 0.5 mm laminate coating

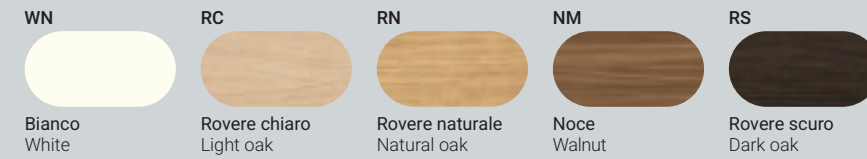

- F** Piani scrivania sp. 50 mm realizzati con pannello ligneo e con rivestimento in laminatino Fenix sp. 0.8 mm  
Worktops manufactured with th. 50 mm and wood panel with Fenix coating with th. 0.8 mm Fenix coating

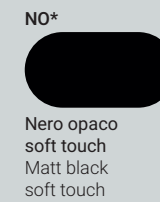

- V** Piani scrivania sp. 47 mm realizzati con pannello ligneo con applicata una lastra in vetro sp. 5 mm temprato retrolaccato con bordi perimetrali lavorati a filo lucido  
Worktops manufactured with th. 47 mm wood panel on which a th. 5 mm rear-laquered tempered glass-plate, with outer polished edges, is applied



- V** Piani scrivania sp. 47 mm realizzati con pannello ligneo con applicata una lastra in vetro sp. 5 mm temprato retrolaccato acidato con bordi perimetrali lavorati a filo lucido  
Worktops manufactured with th. 47 mm wood panel on which a th. 5 mm rear-laquered acetated tempered glass-plate, with outer polished edges, is applied

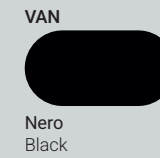

- M** Modesty panel sp. 18 mm  
Modesty panel th. 18 mm

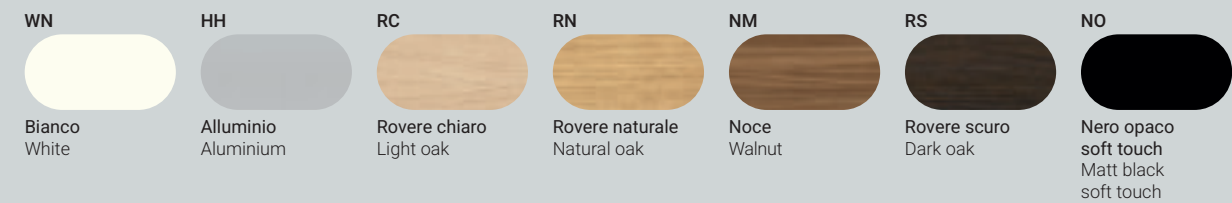

- MT** Strutture metalliche  
Metal structures



#### LEGENDA LEGEND

**M** Melaminico  
Melamine

**F** Fenix  
Fenix

**L** Laminatino  
Laminate

**MT** Metallo  
Metal

\* Non in pronta consegna  
\* Not in prompt delivery

Per finiture mobile di servizio consultare pag 180 - 181  
See pages 180 - 181 for service unit finishes

Dati tecnici  
Technical data

Scrivania  
Desks

Scrivania P 90 - P 100  
D 90 - D 100 desk



L/W 180	P/D 90	H/H 75
200	100	75
220		

Scrivania P 90 - P 100  
D 90 - D 100 desk

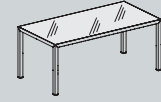

L/W 180	P/D 90	H/H 75
200	100	75
220		

Allungo  
Desk return

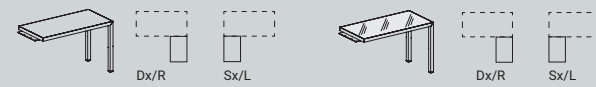

L/W 120	P/D 60	H/H 75	M
120	60	75	V

Scrivania P 100 integrabile con mobile di servizio  
Desk D 100 to be connected to the service unit



L/W 200	P/D 100	H/H 75	M
220	100	75	V

Scrivania P 160 integrabile con mobile di servizio  
Desk D 160 to be connected to the service unit

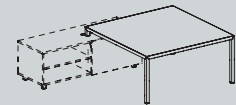

L/W 160	P/D 160	H/H 75
---------	---------	--------

Scrivania P 160 integrabile con mobile di servizio  
Desk D 160 to be connected to the service unit

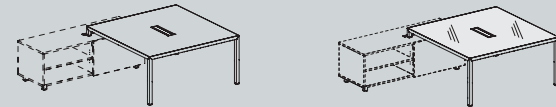

L/W 160	P/D 160	H/H 75	M
160	160	75	V

Mobile di servizio - P 66, P 92.5 - Indicare Dx o Sx  
Service unit - D 66, D 92.5 - Specify R or L

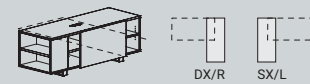

L/W 180	P/D 66	H/H 61
---------	--------	--------

Tavoli riunione  
Meeting tables

Tavolo riunioni  
Meeting table

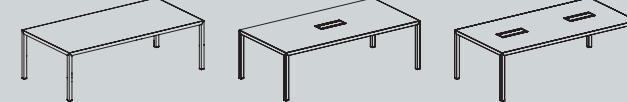

L/W 240	P/D 120	H/H 75
300		
400		

Tavolo riunioni  
Meeting table

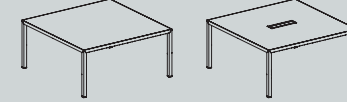

L/W 160	P/D 160	H/H 75
---------	---------	--------

Tavolo riunioni in vetro  
Meeting table with glass

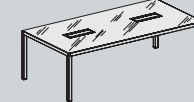

L/W 240	P/D 120	H/H 75
300		

Tavolo riunioni in vetro  
Meeting table with glass

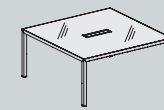

L/W 160	P/D 160	H/H 75
---------	---------	--------

M Melaminico  
Melamine

V Vetro  
Glass

Dimensioni espresse in centimetri  
Dimensions stated in centimetres

Per finiture mobile di servizio consultare pag 180 - 181  
See pages 180 - 181 for service unit finishes



DV901 - VERTIGO



DV901 - VERTIGO



DV901 - VERTIGO  
lato operatore  
operator side

## Finiture Finishes

### Scrivania Desk

**M** Piani scrivania sp. 18 mm e modesty panel sp. 18 mm  
Worktops th. 18 mm and modesty panel th. 18 mm



**M** Solo per modesty panel sp. 18 mm  
Only for modesty panel th. 18 mm

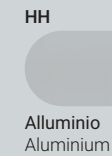

**V** Piani scrivania in vetro sp. 10 mm temperato retrolaccato  
Rear-lacquered tempered glass worktops th. 10 mm



**V** Piani scrivania in vetro sp. 10 mm temperato retrolaccato. Acidato lato superiore  
Rear-lacquered acetated tempered glass worktops th. 10 mm

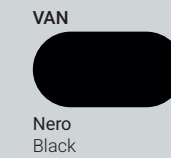

**MT** Strutture metalliche  
Metal structures



**MT** Travi in metallo  
Metal beams



#### LEGENDA LEGEND

**M** Melaminico  
Melamine

**MT** Metallo  
Metal

\* Non in pronta consegna  
\* Not in prompt delivery

**V** Vetro  
Glass

Per finiture mobile di servizio consultare pag 180 - 181  
See pages 180 - 181 for service unit finishes

Dati tecnici  
Technical data

Scrivania  
Desks

Scrivania - Piano melaminico - P 80 - P 90  
Desk - Melamine worktop - D 80 - D 90 desks

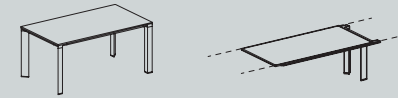

L/W	160 180 200	P/D	80 90 90	H/H	75
-----	-------------------	-----	----------------	-----	----

Scrivania - Piano melaminico - P 60  
Desk - Melamine worktop - D 60



L/W	120	P/D	60	H/H	75
-----	-----	-----	----	-----	----

Allungo - Piano melaminico - P 60  
Desk return - Melamine worktop - D 60

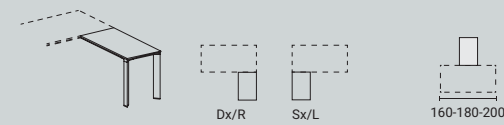

L/W	120	P/D	60	H/H	75
-----	-----	-----	----	-----	----

Scrivania - Gamba chiusa - P 90  
Desk - Loop leg - D 90

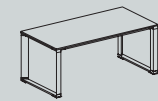

L/W	180 200	P/D	90	H/H	75
-----	------------	-----	----	-----	----

Scrivania - Gamba chiusa - Piano melaminico - P 60  
Desk - Loop leg - Melamine worktop - D 60



L/W	120	P/D	60	H/H	75
-----	-----	-----	----	-----	----

Allungo - Gamba chiusa - Piano melaminico - P 60  
Desk return - Loop leg - Melamine worktop - D 60

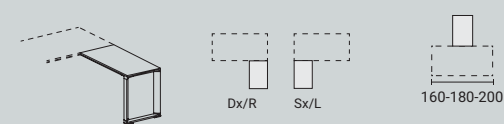

L/W	120	P/D	60	H/H	75
-----	-----	-----	----	-----	----

Scrivania in vetro - P 80 - P 90  
Glass desk - D 80 - D 90



L/W	160 180 200	P/D	80 90 90	H/H	74.5
-----	-------------------	-----	----------------	-----	------

Scrivania in vetro - P 60  
Glass desk - D 60

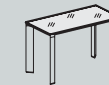

L/W	120	P/D	60	H/H	74.5
-----	-----	-----	----	-----	------

Allungo in vetro - P 60  
Glass desk return - D 60

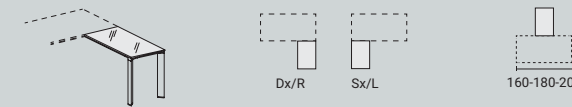

L/W	120	P/D	60	H/H	74.5
-----	-----	-----	----	-----	------

Scrivania in vetro - Gamba chiusa - P 90  
Glass desk - Loop leg - D 90

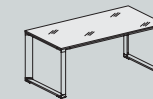

L/W	180 200	P/D	90	H/H	75
-----	------------	-----	----	-----	----

Scrivania in vetro - Gamba chiusa - P 60  
Glass desk - Loop leg - D 60

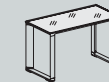

L/W	120	P/D	60	H/H	74.5
-----	-----	-----	----	-----	------

Allungo in vetro - Gamba chiusa - P 60  
Glass desk return - Loop leg - D 60

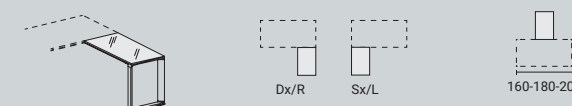

L/W	120	P/D	60	H/H	74.5
-----	-----	-----	----	-----	------

M Melaminico  
Melamine

V Vetro  
Glass

Dimensioni espresse in centimetri  
Dimensions stated in centimetres

Per finiture mobile di servizio consultare pag 180 - 181  
See pages 180 - 181 for service unit finishes



Dati tecnici  
Technical data

Scrivania  
Desks

Scrivania integrabile con mobile di servizio  
Desk to be connected to the service unit



L/W	180 200	P/D	90	H/H	75	<input type="checkbox"/> M
	180 200		90		74.5	<input type="checkbox"/> V

Scrivania integrabile con mobile di servizio  
Desk to be connected to the service unit



L/W	160	P/D	160	H/H	75	<input type="checkbox"/> M
	160		160		74.5	<input type="checkbox"/> V

Scrivania integrabile con mobile di servizio  
Desk to be connected to the service unit

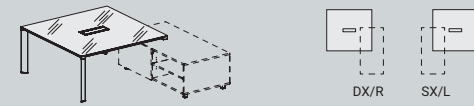

L/W	160	P/D	160	H/H	75	<input type="checkbox"/> M
	160		160		74.5	<input type="checkbox"/> V

Mobile di servizio - P 66, P 92.5 - Indicare Dx o Sx  
Service unit - D 66, D 92.5 - Specify R or L

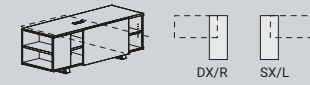

L/W	180	P/D	66	H/H	61
-----	-----	-----	----	-----	----

Modesty panel  
Modesty panel

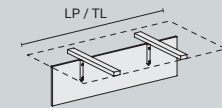

LP/TL	160 180 200	L/W	140 160 180	P/D	1.8	H/H	38
-------	-------------------	-----	-------------------	-----	-----	-----	----

Modesty panel - Per tavolo L 180 - Con mobile di servizio  
Modesty panel - For table W 180 - With service unit

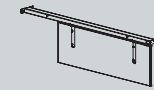

L/W	120	P/D	1.8	H/H	38
-----	-----	-----	-----	-----	----

Modesty panel - Per tavolo L 200 - Con mobile di servizio  
Modesty panel - For desk W 200 - With service unit

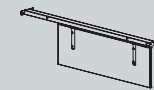

L/W	140	P/D	1.8	H/H	38
-----	-----	-----	-----	-----	----

Modesty panel - Per tavolo 160x160  
Modesty panel - For table 160x160

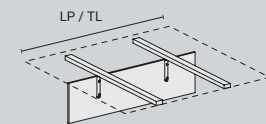

LP/TL	160	L/W	140	P/D	1.8	H/H	38
-------	-----	-----	-----	-----	-----	-----	----

Tavoli riunione  
Meeting tables

Tavolo riunioni - P 100  
Meeting table - D 100



L/W	100	P/D	100	H/H	75
-----	-----	-----	-----	-----	----

Tavolo riunioni - P 140 - P 160  
Meeting table - D 140 - D 160

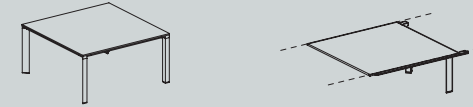

L/W	140 160	P/D	140 160	H/H	75
-----	------------	-----	------------	-----	----

Tavolo riunioni - P 120  
Meeting table - D 120



L/W	240	P/D	120	H/H	75	<input type="checkbox"/> M
	240		120		74.5	<input type="checkbox"/> V

Tavolo riunioni in vetro - P 160  
Meeting table with glass - D 160



L/W	160	P/D	160	H/H	74.5
-----	-----	-----	-----	-----	------

Tavolo riunioni in vetro  
Meeting table with glass



L/W	100	P/D	100	H/H	74.5
-----	-----	-----	-----	-----	------



DV902 - PLANETA



DV902 - PLANETA

## Finiture Finishes

### Scrivania Desk

**M** Piani scrivania sp. 18 mm. Modesty panel sp. 18 mm. Gambe pannellate sp. 80 mm  
Worktops th. 18 mm. Modesty panel th. 18 mm. Panelled legs th. 80 mm

**RC**



Rovere chiaro  
Light oak

**RN**



Rovere naturale  
Natural oak

**NM**



Noce  
Walnut

**RS**



Rovere scuro  
Dark oak

**BN\***

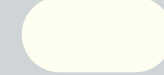

Bianco opaco  
soft touch  
Matt white  
soft touch

**TA\***



Tortora  
soft touch  
Taupe  
soft touch

**VO\***



Verde opaco  
soft touch  
Matt green  
soft touch

**GF\***



Grafite  
soft touch  
Graphite  
soft touch

**NO\***



Nero opaco  
soft touch  
Matt black  
soft touch

**M** Solo per modesty panel sp. 18 mm  
Only for modesty panel th. 18 mm

**HH**

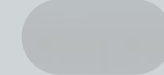

Alluminio  
Aluminium

**V** Piani scrivania in vetro sp. 10 mm temperato retrolaccato  
Rear-lacquered tempered glass worktops th. 10 mm

**VW**



Bianco  
White

**V** Piani scrivania in vetro sp. 10 mm temperato retrolaccato. Acidato lato superiore  
Rear-lacquered acetated tempered glass worktops th. 10 mm

**VAN**



Nero  
Black

**MT** Strutture metalliche  
Metal structures

**W**

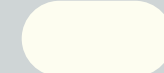

Bianco  
White

**H**

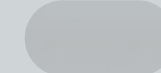

Alluminio  
Aluminium

**A**



Antracite  
Anthracite

**TA\***



Tortora  
Taupe

**VO\***



Verde opaco  
Matt green

**GF\***



Grafite  
Graphite

**N\***



Nero  
Black

**MT** Travi in metallo  
Metal beams

**HH**

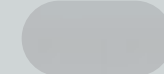

Alluminio  
Aluminium

#### LEGENDA LEGEND

**M** Melaminico  
Melamine

**MT** Metallo  
Metal

**V** Vetro  
Glass

\* Non in pronta consegna  
\* Not in prompt delivery

Per finiture mobile di servizio consultare pag 180 - 181  
See pages 180 - 181 for service unit finishes

Dati tecnici  
Technical data

Scrivania  
Desk

Scrivania P 90 - Piano melaminico  
Desk D 90 - Melamine worktop

L/W 180 |  
200 | P/D 90 | H/H 75 |

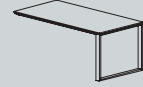

Scrivania P 90 - Piano melaminico - Gambe pannellate  
Desk D 90 - Melamine worktop - Panelled legs

L/W 180 |  
200 | P/D 90 | H/H 75 |

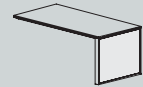

Scrivania P 90 - Piano in vetro  
Desk D 90 - Glass worktop

L/W 180 |  
200 | P/D 90 | H/H 75 |

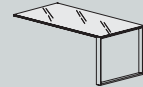

Scrivania P 90 - Piano in vetro - Gambe pannellate  
Desk D 90 - Glass worktop - Panelled legs

L/W 180 |  
200 | P/D 90 | H/H 75 |

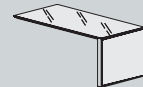

Mobile di servizio - P 66 - Indicare Dx o Sx  
Service unit - D 66 - Specify R or L

L/W 180 | P/D 66 | H/H 61 |



Tavoli riunione  
Meeting tables

Tavolo riunioni - P 100  
Meeting table - D 100

L/W 100 | P/D 100 | H/H 75 |



Tavolo riunioni - P 140 - P 160  
Meeting table - D 140 - D 160

L/W 140 |  
160 | P/D 140 |  
160 | H/H 75 |



Tavolo riunioni - P 120  
Meeting table - D 120

L/W 240 | P/D 120 | H/H 75 |  M  
240 | 120 | 74.5 |  V



Tavolo riunioni in vetro - P 160  
Meeting table with glass - D 160

L/W 160 | P/D 160 | H/H 74.5 |  M  
160 | 160 | 74.5 |  V

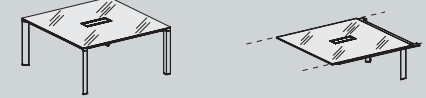

Tavolo riunioni in vetro  
Meeting table with glass

L/W 100 | P/D 100 | H/H 74.5 |



M Melaminico  
Melamine

MT Metallo  
Metal

Dimensioni espresse in centimetri  
Dimensions stated in centimetres

Per finiture mobile di servizio consultare pag 180 - 181  
See pages 180 - 181 for service unit finishes

RYM | VERTIGO | PLANETA  
DV905 | DV901 | DV902

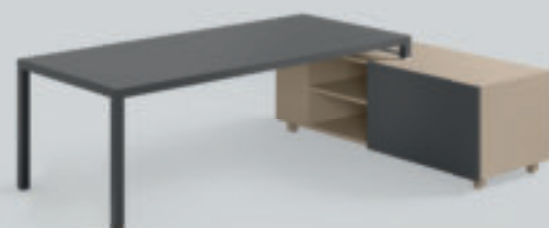

DV902 - RYM  
lato operatore  
operator side



DV901 - VERTIGO  
lato operatore  
operator side









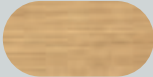

DV902 - PLANETA

## Finiture Finishes

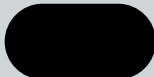
### Mobile di servizio Service unit

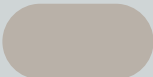
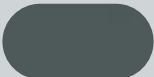

**M** Mobile di servizio P 66, sp. 18/25 mm, cassettera per vano interno, ripiano sp. 25 mm, in melaminico  
Service unit D 66, th. 18/25, pedestal for inside service unit, shelf th. 25 mm, in melamine

<b>WN</b>  Bianco White	<b>RC</b>  Rovere chiaro Light oak	<b>RN</b>  Rovere naturale Natural oak	<b>NM</b>  Noce Walnut	<b>RS</b>  Rovere scuro Dark oak
<b>NO</b>  Nero opaco soft touch Matt black soft touch	<b>BN*</b>  Bianco opaco soft touch Matt white soft touch	<b>TA*</b>  Tortora soft touch Taupe soft touch	<b>VO*</b>  Verde opaco soft touch Matt green soft touch	<b>GF*</b>  Grafite soft touch Graphite soft touch

**MT** Top access in alluminio  
Top access in aluminium

<b>W</b>  Bianco White	<b>HN</b>  Nero anodizzato Anodized black	<b>HH</b>  Alluminio anodizzato Anodized aluminium
--	---	--

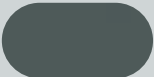
**MT** Strutture metalliche  
Metal structures

<b>W</b>  Bianco White	<b>H</b>  Alluminio Aluminium	<b>A</b>  Antracite Anthracite	<b>TA*</b>  Tortora Taupe	<b>VO*</b>  Verde opaco Matt green	<b>GF*</b>  Grafite Graphite	<b>N*</b>  Nero Black
--	---	--	---	--	--	---

#### LEGENDA LEGEND

**M** Melaminico  
Melamine  
**MT** Metallo  
Metal

\* Non in pronta consegna  
\* Not in prompt delivery



DV914 - DAKAR



DV914 - DAKAR  
lato operatore  
operator side

## Finiture Finishes

### Scrivania - Tavoli riunione Desk - Meeting tables

**M** Piani scrivania sp. 25 mm e modesty panel sp. 18 mm  
Worktops th. 25 mm and modesty panel th. 18 mm

<b>WN</b>  Bianco White	<b>RC</b>  Rovere chiaro Light oak	<b>RN</b>  Rovere naturale Natural oak	<b>NM</b>  Noce Walnut	<b>RS</b>  Rovere scuro Dark oak
<b>BN*</b>  Bianco opaco soft touch Matt white soft touch	<b>TA*</b>  Tortora soft touch Taupe soft touch	<b>VO*</b>  Verde opaco soft touch Matt green soft touch	<b>GF*</b>  Grafite soft touch Graphite soft touch	<b>NO*</b>  Nero opaco soft touch Matt black soft touch

**MT** Strutture metalliche  
Metal structures

<b>W</b>  Bianco White	<b>X</b>  Cromo Chrome	<b>A</b>  Antracite Anthracite
---------------------------------	---------------------------------	---

**PE** Puntale livellatore in polietilene  
Polyethylene levelling feet

<b>X</b>  Cromo Chrome
---------------------------------

**MT** Travi in metallo  
Metal beams

<b>HH</b>  Alluminio Aluminium
---

### Mobile di servizio Service unit

**M** Mobile di servizio P 66, sp. 18/25 mm, cassettera per vano interno, ripiano sp. 25 mm, in melaminico  
Service unit D 66, th. 18/25, pedestal for inside service unit, shelf th. 25 mm, in melamine

<b>WN</b>  Bianco White	<b>RC</b>  Rovere chiaro Light oak	<b>RN</b>  Rovere naturale Natural oak	<b>NM</b>  Noce Walnut	<b>RS</b>  Rovere scuro Dark oak
<b>BN*</b>  Bianco opaco soft touch Matt white soft touch	<b>TA*</b>  Tortora soft touch Taupe soft touch	<b>VO*</b>  Verde opaco soft touch Matt green soft touch	<b>GF*</b>  Grafite soft touch Graphite soft touch	<b>NO*</b>  Nero opaco soft touch Matt black soft touch

#### LEGENDA LEGEND

**M** Melaminico  
Melamine

**PE** Polietilene  
Polyethylene

**MT** Metallo  
Metal

\* Non in pronta consegna  
\* Not in prompt delivery

Dati tecnici  
Technical data

Scrivania  
Desk

Scrivania P 80 - P 100 - P 120  
D 80 - D 100 - D 120

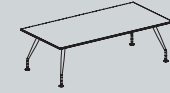

L/W	180	P/D	80	H/H	75
	200		100		
	240		120		

Allungo  
Desk return



L/W	100	P/D	65	H/H	75
-----	-----	-----	----	-----	----

Scrivania integrabile con mobile di servizio o moduli DV504-Milo  
Desk to be connected to the service unit or base modules DV504-Milo

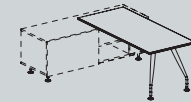

L/W	180	P/D	80	H/H	75
	200		100		

Scrivania con 3 gambe e 1 sostegno - Integrabile con mobile di servizio o moduli DV504-Milo  
Desk with 3 legs and 1 support - To be connected to the service unit or DV504-Milo base modules



L/W	160	P/D	160	H/H	75
-----	-----	-----	-----	-----	----

Scrivania con 2 gambe e 2 sostegni - Integrabile SOLO con moduli DV504-Milo  
Desk with 2 legs and 2 supports - To be connected ONLY with DV504-Milo base modules

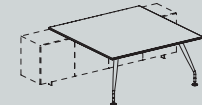

L/W	160	P/D	160	H/H	75
-----	-----	-----	-----	-----	----

Scrivania integrabile con mobile di servizio o moduli DV504-Milo  
Desk to be connected to the service unit or base modules DV504-Milo

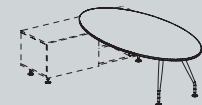

L/W	250	P/D	125	H/H	75
-----	-----	-----	-----	-----	----

Modesty panel in melaminico  
Melamine modesty panel

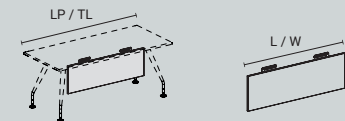

LP/TL	160	L/W	100	P/D	1.8	H/H	35
	180		120				
	200		140				
	250		140				

Modesty panel in melaminico - Per scrivania integrabile  
Melamine modesty panel - For suspended desk



LP/TL	160	L/W	100	P/D	1.8	H/H	35
	180		100				
	200		120				
	250		120				

Mobile di servizio - P 66 - Indicare Dx o Sx  
Service unit - D 66 - Specify R or L

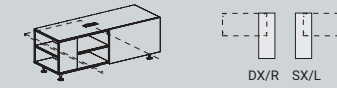

L/W	180	P/D	66	H/H	61
-----	-----	-----	----	-----	----

Tavoli riunione  
Meeting tables

Tavolo riunioni - P 160  
Meeting table - D 160



L/W	160	P/D	160	H/H	75
-----	-----	-----	-----	-----	----

Tavolo riunioni - P 125  
Meeting table - D 125



L/W	250	P/D	125	H/H	75
-----	-----	-----	-----	-----	----

Tavolo riunioni - Ø 120  
Meeting table - Ø 120



L/W	120	P/D	120	H/H	75
-----	-----	-----	-----	-----	----

Tavolo riunioni integrabile con mobile di servizio  
Meeting table to be connected to the service unit

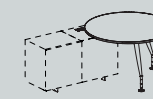

L/W	120	P/D	120	H/H	75
-----	-----	-----	-----	-----	----



DV910 - OXFORD



DV910 - OXFORD



DV910 - OXFORD  
lato operatore  
operator side

## Finiture Finishes

### Scrivania - Tavoli riunione Desk - Meeting tables

**M** Piano operatore sp. 38 mm - Modesty panel sp. 25 mm  
User-side worktop th. 38 mm - Modesty panel th. 25 mm



**M** Piano visitatore  
Visitor-side worktop

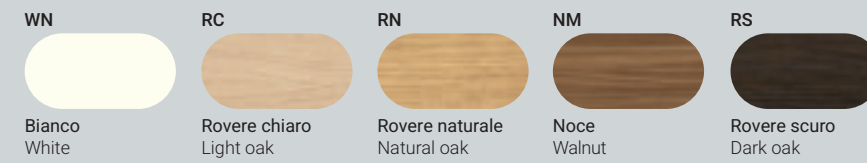

**M** Gambe pannellate sp. 38 mm  
Pannelled legs th. 38 mm

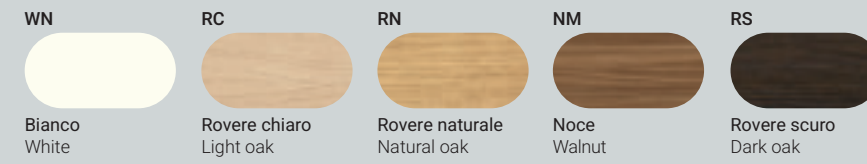

**MT** Colonne per regolazione in altezza da 64.5 a 130 cm  
Columns for height adjustment from 64.5 to 130 cm



### Mobile di servizio Service cabinet

**M** Scocca in melaminico sp. 25/38 mm - Ripiani in melaminico sp. 25 mm  
Th. 25/38 mm melamine structure - th. 25 mm melamine shelves

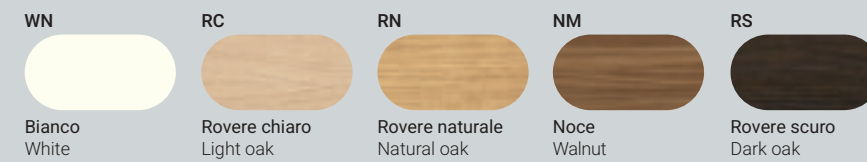

**M** Ante sp.18 mm bordate in ABS  
Th. 18 mm doors edged in ABS perimeter



#### LEGENDA LEGEND

**M** Melaminico  
Melamine

**MT** Metallo  
Metal

**T** Tessuto  
Fabric

\* Non in pronta consegna  
\* Not in prompt delivery



DV910 - OXFORD

## Finiture Finishes

### Mobile multifunzione\* Multifunctional cabinet\*

**M** Scocche sp. 38 mm  
Structure th. 38 mm

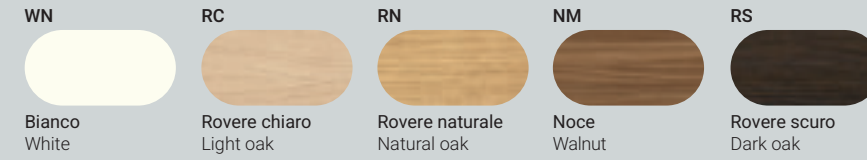

**M** Ante sp. 18 mm - Piani scrivania sp. 38 mm  
Doors th. 18 mm - Worktops th. 38 mm



**T** Schiena puntinabile  
Pinnable backpanel



#### LEGENDA LEGEND

**M** Melaminico  
Melamine

**T** Tessuto  
Fabric

\* Non in pronta consegna  
\* Not in prompt delivery



Dati tecnici  
Technical data

Scrivania  
Desk

Scrivania - Piano melaminico - P 90  
Desk - Melamine worktop - D 90

L/W	184 204 224	P/D	90	H/H	75
-----	-------------------	-----	----	-----	----

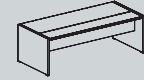

Scrivania - Indicare Dx o Sx  
Desk - Specify R o L

L/W	180 200 220	P/D	90	H/H	75
-----	-------------------	-----	----	-----	----



Scrivania con allungo  
Desk with extension

L/W	180 200 220	P/D	210	H/H	75
-----	-------------------	-----	-----	-----	----



Scrivania con mobile di servizio  
Desk with service unit

LP/TL	180 200 220	L/W	210 230 250	P/D	210	H/H	75
-------	-------------------	-----	-------------------	-----	-----	-----	----



Scrivania con piano sliding e mobile di servizio  
Desk with sliding tops and service unit

LP/TL	180 200 220	L/W	210 230 250	P/D	210	H/H	75
-------	-------------------	-----	-------------------	-----	-----	-----	----



Scrivania regolabile in altezza elettricamente  
Desk with electric height adjustment

L/W	180 200 220	P/D	90	H/H	75+141
-----	-------------------	-----	----	-----	--------

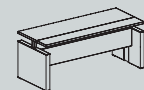

Scrivania regolabile in altezza elettricamente - Con mobile di servizio  
Desk with electric height adjustment - With service unit

L/W	180 200 220	P/D	214	H/H	75+141
-----	-------------------	-----	-----	-----	--------



Penisola con gambe  
End meeting element with leg

L/W	120	P/D	120	H/H	75
-----	-----	-----	-----	-----	----

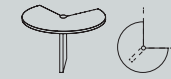

Contenitore multifunzione  
Multi-purpose storage unit

L/W	250	P/D	60	H/H	190
-----	-----	-----	----	-----	-----

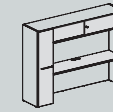

Composizione con scrivania e contenitore multifunzione  
Composition with desk and multi-purpose storage unit

LP/TL	200 220	L/W	250	P/D	266	H/H	190
-------	------------	-----	-----	-----	-----	-----	-----

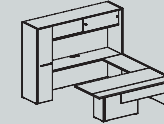

Tavoli riunione  
Meeting table

Tavolo riunioni - P 140  
Meeting table - D 140

L/W	140	P/D	140	H/H	75
-----	-----	-----	-----	-----	----

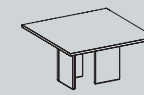

Tavolo riunioni - P 120  
Meeting table - D120

L/W	240	P/D	120	H/H	75
-----	-----	-----	-----	-----	----

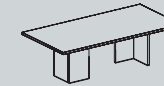

Tavolino caffè  
Coffee table

L/W	60 120	P/D	60	H/H	45
-----	-----------	-----	----	-----	----





DV504 - MILO



DV504 - MILO



DV504 - MILO

## Finiture Finishes

### Contenitore Cabinet

**M** Scocche in Folding - melaminico sp. 18 mm  
Folding structures - melamine th. 18 mm

<b>WN</b>	<b>RN</b>	<b>NM</b>	<b>BN*</b>	<b>TA*</b>	<b>VO*</b>	<b>GF*</b>	<b>NO*</b>
Bianco White	Rovere naturale Natural oak	Noce Walnut	Bianco opaco soft touch Matt white soft touch	Tortora soft touch Taupe soft touch	Verde opaco soft touch Matt green soft touch	Grafite soft touch Graphite soft touch	Nero opaco soft touch Matt black soft touch

**M** Ante / frontali / schiene in melaminico sp. 18 mm  
Melamine doors / drawers fronts / backs th. 18 mm

<b>WN</b>	<b>RC</b>	<b>RN</b>	<b>NM</b>	<b>RS</b>	<b>GQ</b>	<b>VM</b>	<b>TD</b>
Bianco White	Rovere chiaro Light oak	Rovere naturale Natural oak	Noce Walnut	Rovere scuro Dark oak	Grigio chiaro Light grey	Verde marino Green marine	Terra d'ombra Umber
<b>BN*</b>	<b>TA*</b>	<b>VO*</b>	<b>GF*</b>	<b>NO*</b>	<b>NC*</b>	<b>CP*</b>	
Bianco opaco soft touch Matt white soft touch	Tortora soft touch Taupe soft touch	Verde opaco soft touch Matt green soft touch	Grafite soft touch Graphite soft touch	Nero opaco soft touch Matt black soft touch	Nocciola Hazelnut	Cappuccino Cappuccino	

**M** Moduli superiori in melaminico sp. 10 / 18 mm  
Upper module in melamine th. 10 / 18 mm

<b>WN</b>	<b>RN</b>	<b>NM</b>	<b>BN*</b>	<b>TA*</b>	<b>VO*</b>	<b>GF*</b>	<b>NO*</b>
Bianco White	Rovere naturale Natural oak	Noce Walnut	Bianco opaco soft touch Matt white soft touch	Tortora soft touch Taupe soft touch	Verde opaco soft touch Matt green soft touch	Grafite soft touch Graphite soft touch	Nero opaco soft touch Matt black soft touch

**MT** Zoccoli metallici  
Metal base frames

<b>W</b>	<b>H</b>	<b>A</b>	<b>N</b>	<b>TA*</b>	<b>VO*</b>	<b>GF*</b>
Bianco White	Alluminio Aluminium	Antracite Anthracite	Nero Black	Tortora Taupe	Verde opaco Matt green	Grafite Graphite

**MT** Barra metallica  
Metal bar

<b>W</b>	<b>H</b>
Bianco White	Alluminio Aluminium

#### LEGENDA LEGEND

**M** Melaminico  
Melamine

**PE** Polietilene  
Polyethylene



**MT** Metallo  
Metal

\* Non in pronta consegna  
\* Not in prompt delivery



Dati tecnici  
Technical data

Scrivania  
Desk





Modulo base L 60  
Base module W 60

			L/W 60	P/D 50	H/H 40
con anta with door	con cassettoni with drawer	c/tappo passacavi with outled lid con vano tecnico per integrazione scrivanie with technical compartment for hanged desk			



Modulo base L 120  
Base module W 120

		L/W 120	P/D 50	H/H 40
con 2 ante with 2 doors	con 2 cassettoni with 2 drawers			

Modulo base L 60  
Base module W 60

					L/W 60	P/D 50	H/H 60
con anta with door	con 2 cassette with 2 drawers	con cassettoni with drawer	Con vano tecnico With technical compartment	Con vano tecnico With technical compartment			

Modulo base L 120  
Base module W 120

		L/W 120	P/D 50	H/H 60
con 2 ante with 2 doors	con 2 cassettoni with 2 drawers			



Modulo base L 60  
Base module W 60

	L/W 60	P/D 50	H/H 120

Modulo superiore L 60  
Upper module W 60

	L/W 60	P/D 48	H/H 20

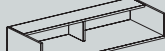
Modulo superiore L 120 - A giorno  
Upper module W 120 - Open

			L/W 120	P/D 48	H/H 20
			L/W 120	P/D 48	H/H 20
			120	48	40

MT Zoccolo metallico H 6.1  
Metal plinth H 6.1

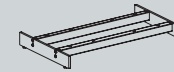

LP/TL 120	L/W 80	P/D 48	H/H 6,1
LP/TL 180	L/W 140	P/D 48	H/H 6,1
LP/TL 240	L/W 200	P/D 48	H/H 6,1

MT Zoccolo metallico H 26.1 - Carter di copertura incluso  
Metal plinth H 26.1 - Cover carter included

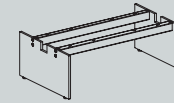

LP/TL 120	L/W 80	P/D 48	H/H 26,1
LP/TL 180	L/W 140	P/D 48	H/H 26,1
LP/TL 240	L/W 200	P/D 48	H/H 26,1

MT Base in metallo - per DV821-Knot  
Metal base - for DV821-Knot

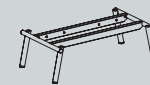

LP/TL 120	L/W 83	P/D 47	H/H 26
LP/TL 180	L/W 143	P/D 47	H/H 26
LP/TL 240	L/W 203	P/D 47	H/H 26

Modulo pensile L 60  
Wall unit module W 60

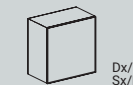
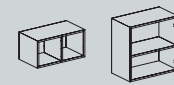

a giorno  
open

con anta  
with door

L/W 60	P/D 34	H/H 30	a giorno open
L/W 60	P/D 36	H/H 60	con anta with door

Modulo pensile L 120  
Wall unit module W 120

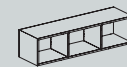

a giorno  
open

L/W 120	P/D 34	H/H 30
---------	--------	--------

Modulo pensile L 30  
Wall unit module W 30

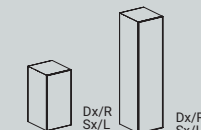
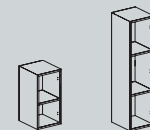

a giorno  
open

con anta  
with door

L/W 30	P/D 34	H/H 60	a giorno open
L/W 30	P/D 36	H/H 60	con anta with door
		120	

MT Barra per pensili e accessori  
Barra per pensili e accessori

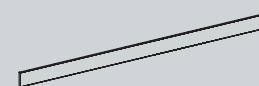

L/W 180	P/D 3	H/H 11
240	3	11

M Melaminico  
Melamine

MT Metallo  
Metal

Dimensioni espresse in centimetri  
Dimensions stated in centimetres

## Specifiche Tecniche Technical Sheets

---

Wire Management	VIGO DV913	p. 198
	NOTO DV911	p. 199
	PLANETA DV902	p. 199
	RYM DV905	p. 200
	VERTIGO DV901	p. 201
	DAKAR DV914	p. 202
	OXFORD DV910	p. 203

---

Plug&Play DV300		p. 204
--------------------	--	--------

VIGO  
DV913

Scrivania  
Desk

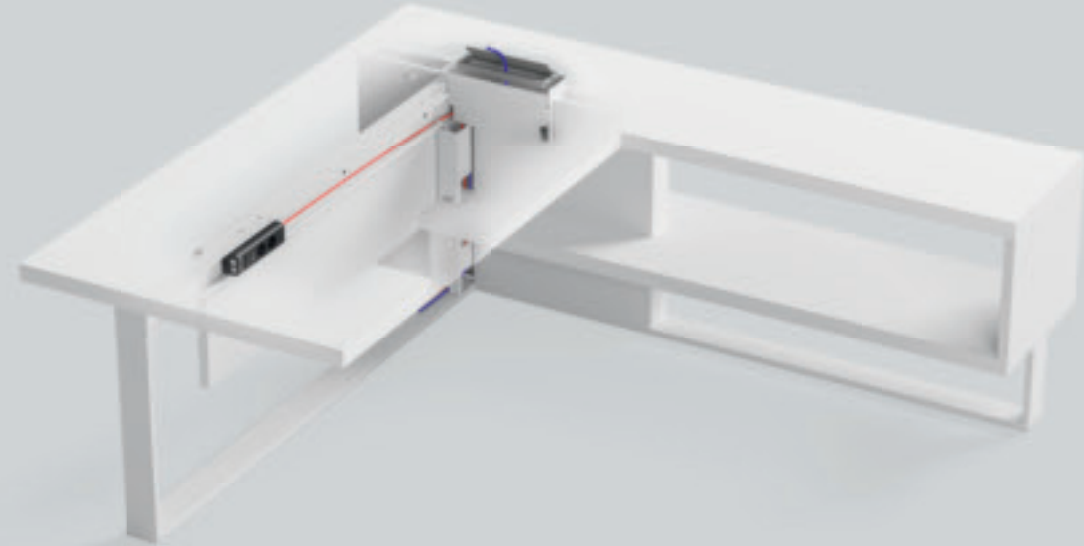

NOTO  
DV911

Scrivania  
Desk

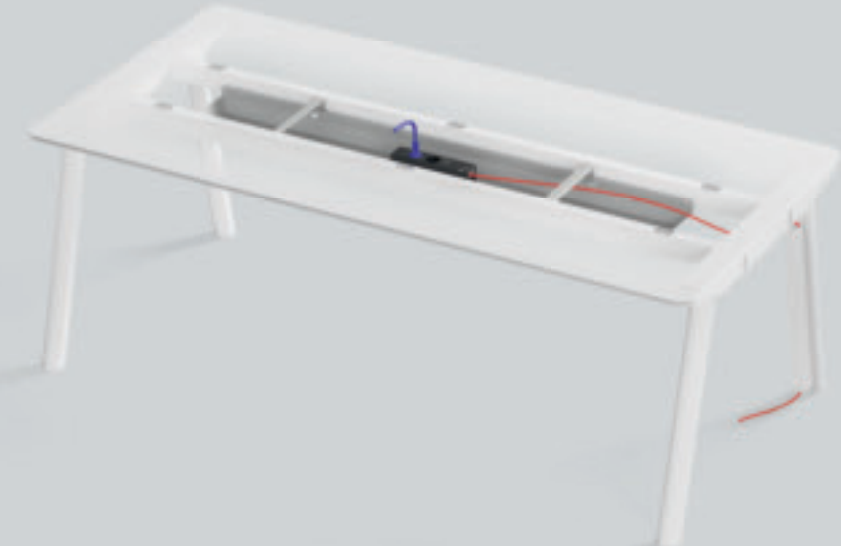

Tavolo riunioni  
Meeting table

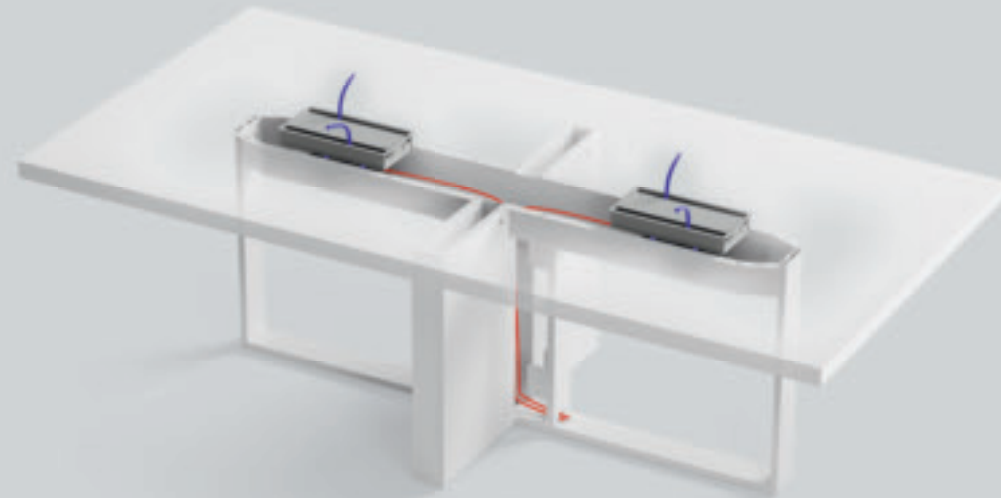

PLANETA  
DV902

Scrivania con mobile di servizio  
Desk with service unit

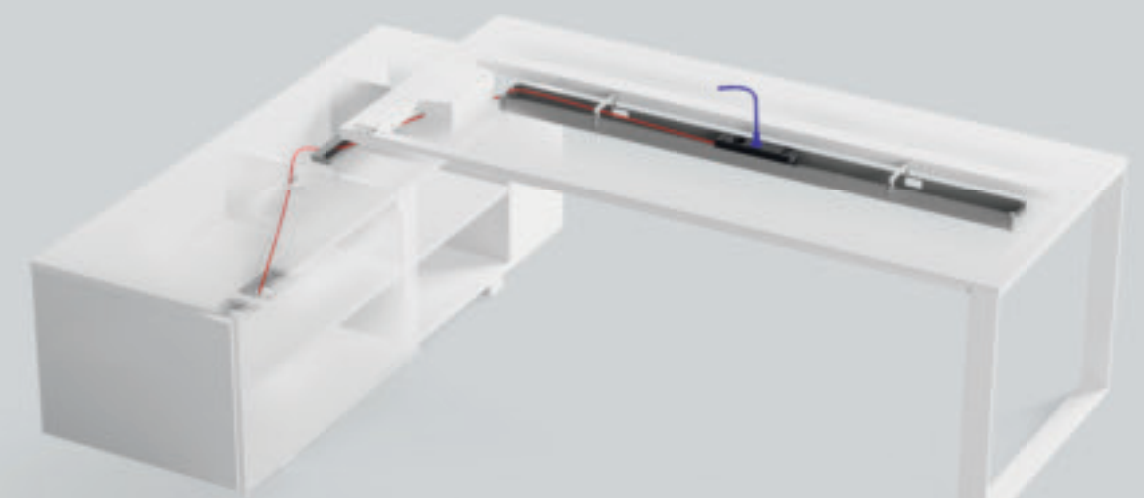

**RYM**  
DV905

Scrivania  
Desk

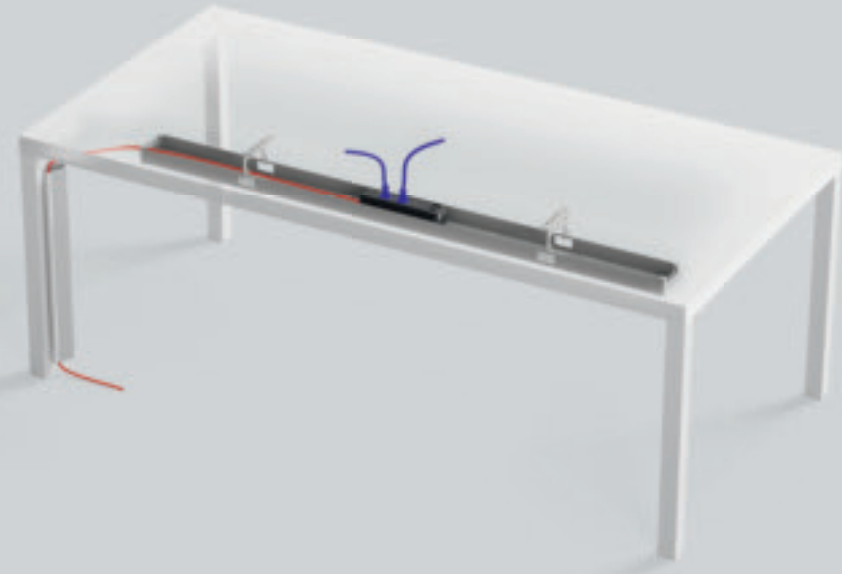

**VERTIGO**  
DV901

Scrivania  
Desk

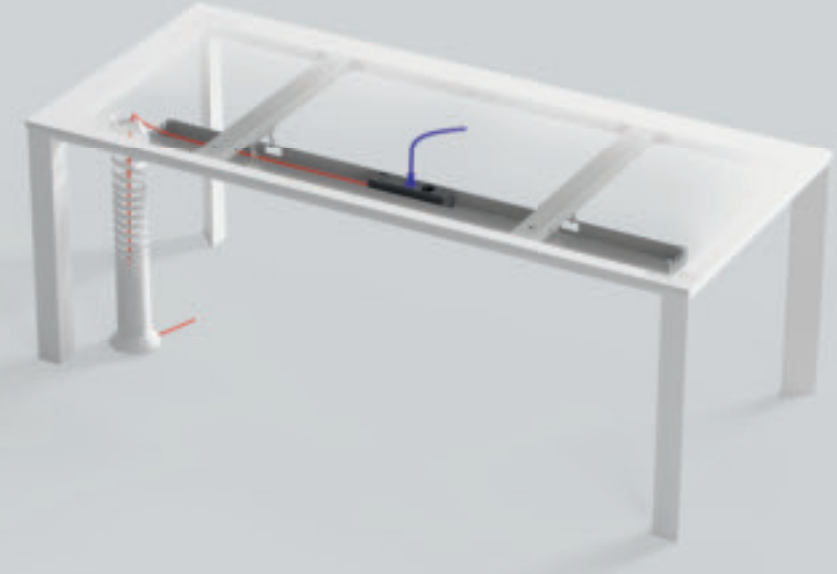

Scrivania con mobile di servizio  
Desk with service unit

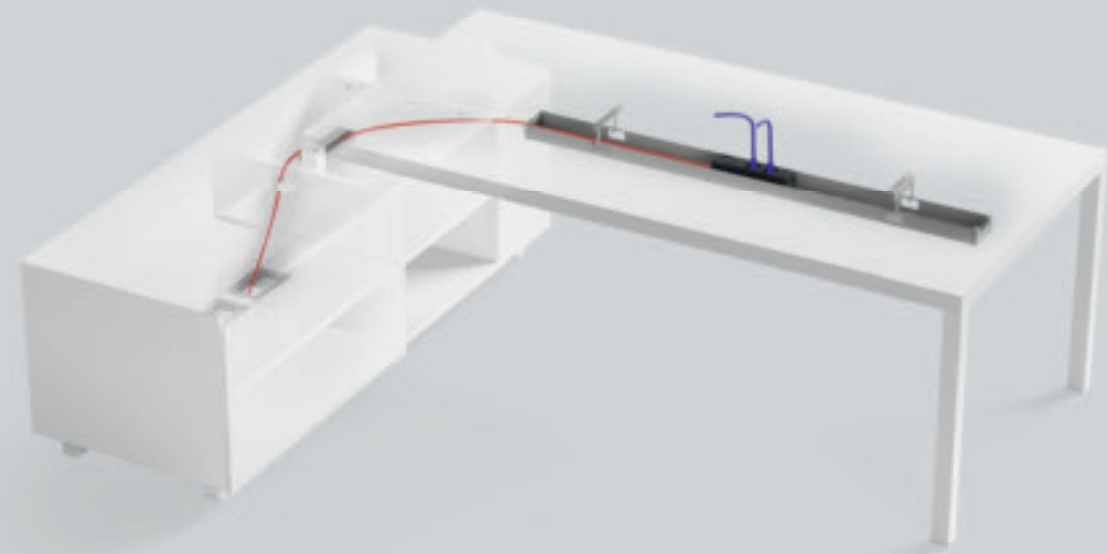

Tavolo riunioni  
Meeting table

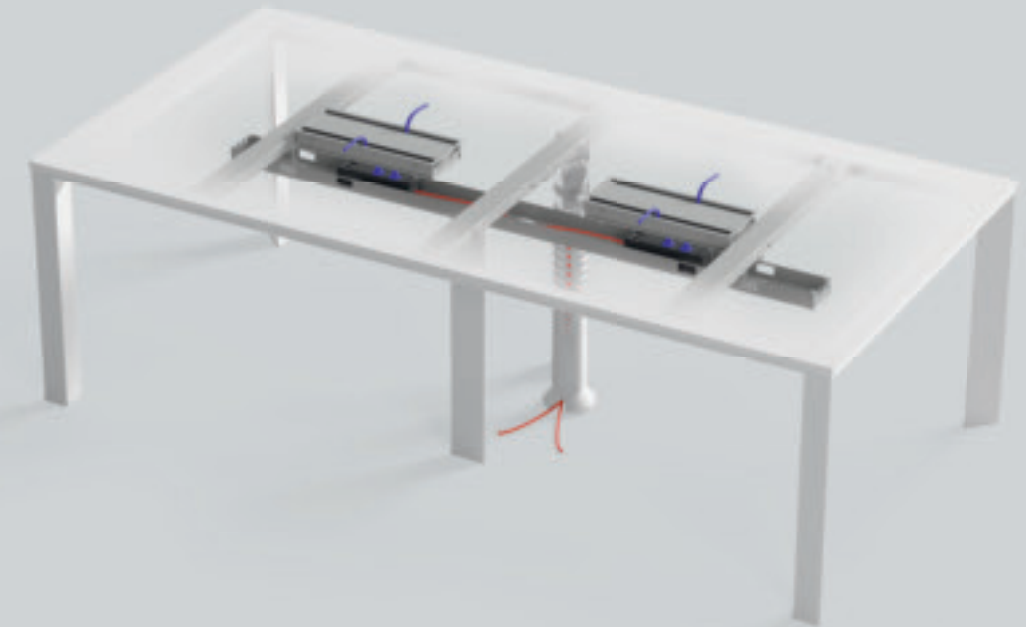

DAKAR  
DV914

Scrivania  
Desk

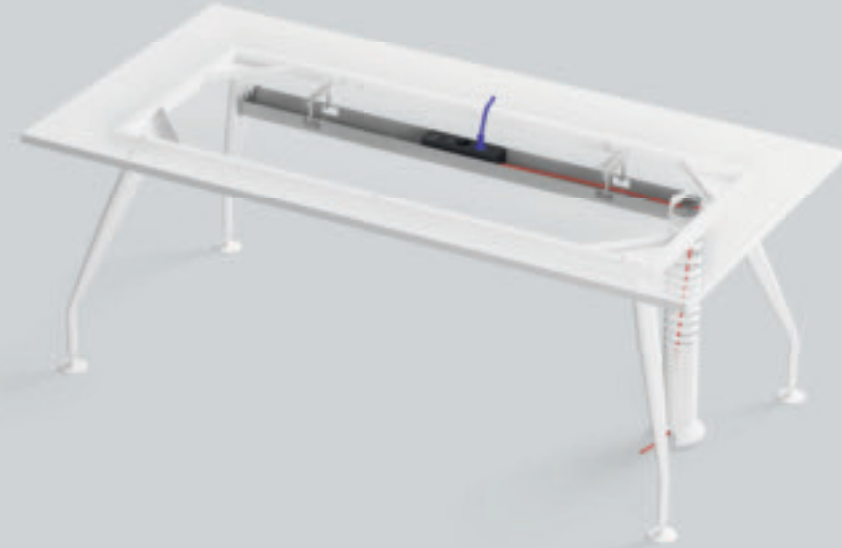

Scrivania con mobile di servizio  
Desk with service unit

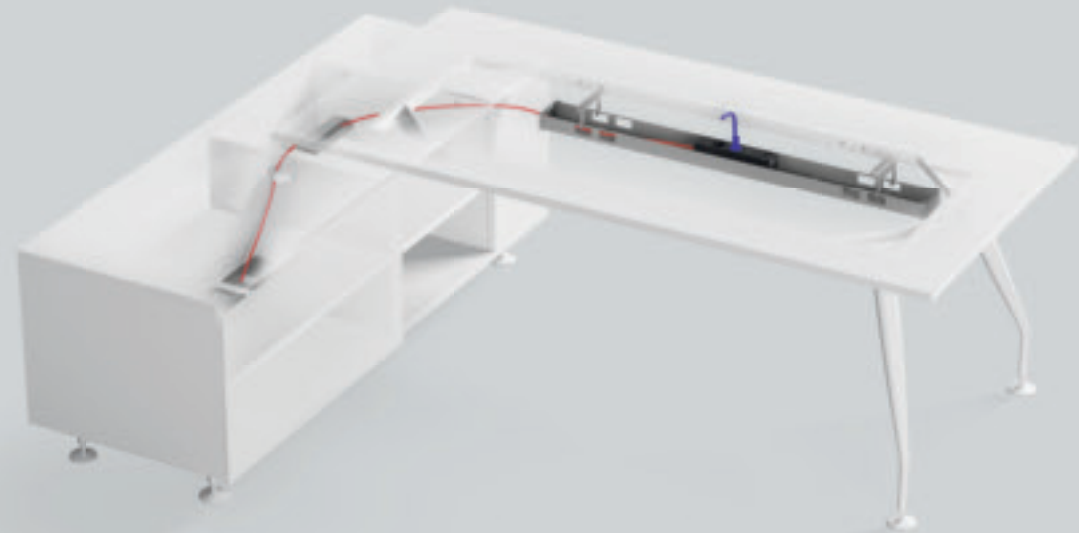

OXFORD  
DV910

Scrivania / Scrivania con mobile di servizio  
Desk / Desk with service unit

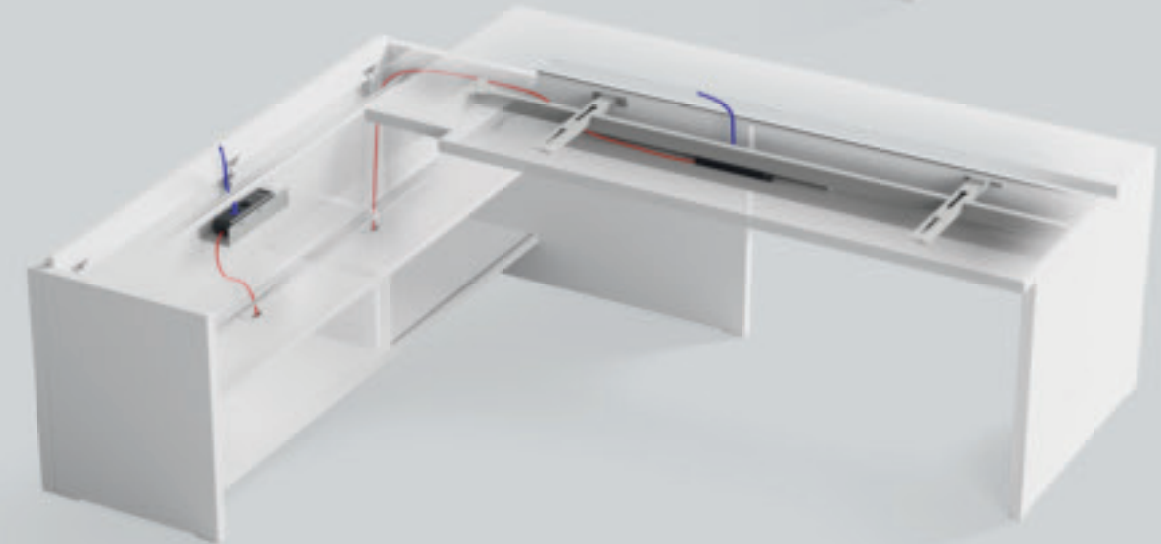
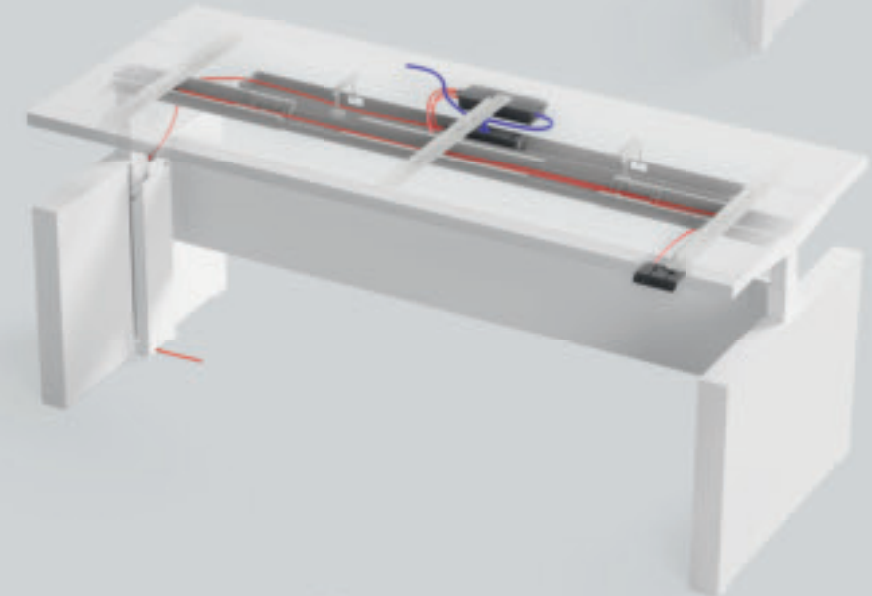
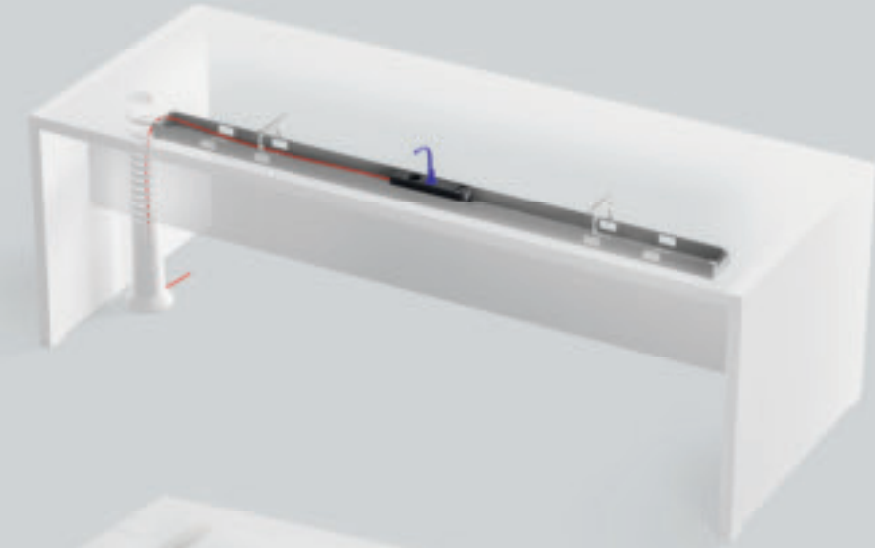

Passacavi bicolore in ABS - Ø 8  
2 coloured outlet lid - Ø 8

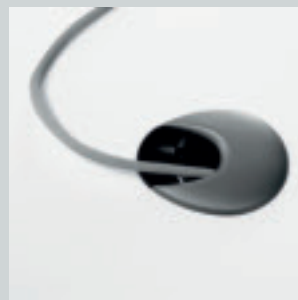

Passacavi in ABS - Ø 6 - 8  
ABS outlet lid - Ø 6 - 8

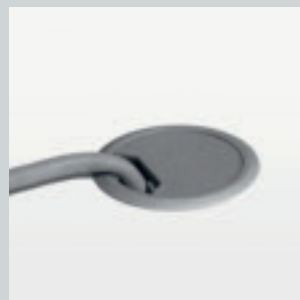

Passacavi in zama - Ø 8  
Zamak outlet lid - Ø 8



Tappo elettrificato - Ø 8  
Electrified grommet - Ø 8



Top access  
Top access

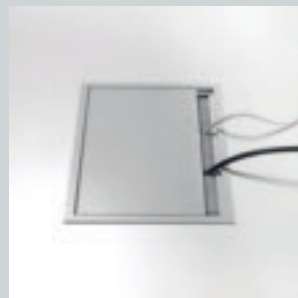

L/W 24 | P/D 10 | H/H 1.5  
L/W 32 | P/D 12.3 | H/H 2.4  
L/W 32 | P/D 12.3 | H/H 3

Top access elettrificato per scrivania  
Electrified top access for desk



L/W 26.3 | P/D 14.8 | H/H 2.5

Top access elettrificato per scrivania  
Electrified top access for desk

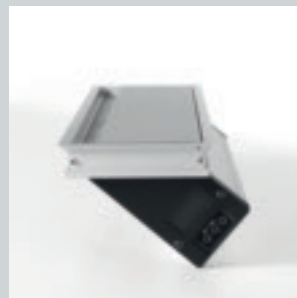

L/W 26.3 | P/D 14.8 | H/H 2.5

Top access per tavoli riunioni  
Top access for meeting tables

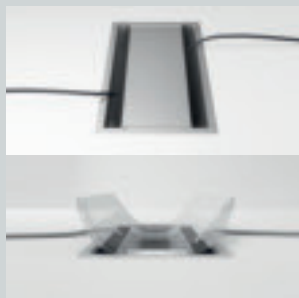

L/W 24.7 | P/D 17.5 | H/H 5  
L/W 34.7 | P/D 17.5 | H/H 5  
L/W 44.7 | P/D 17.5 | H/H 5

Multipresa elettrificata  
Electrified multiple socket



L/W 23.8 | P/D 8.8 | H/H 7.8

Multipresa elettrificata  
Electrified multiple socket



L/W 23.2 | P/D 6.2 | H/H 5.1

Multipresa elettrificata  
Electrified multiple socket



L/W 12 | P/D 7 | H/H 6.6

Presca USB  
USB socket



LEGENDA  
LEGEND

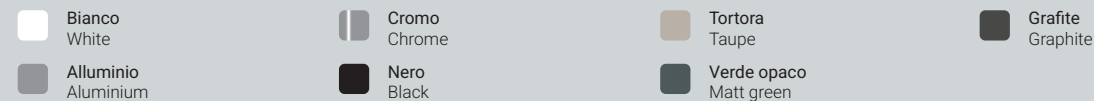

Immagini puramente indicative. Consultare il Listino Prezzi.  
Purely indicative images. See Price List.

Porta CPU con cinghie nere  
CPU holder with black belts



Porta CPU su ruote  
CPU holder on castors



Braccio porta video  
statico su palo  
Static arm for video  
support on deskbase



TIPOLOGIA DI FISSAGGIO  
FIXING TYPOLOGY

Fissaggio su piano singolo  
Fixing on single worktop



Doppio braccio porta video  
statico su palo  
2 static arms for video  
support on pole



Fissaggio su binario centrale  
Fixing on central rail



2 x 3.0 USB Port 0.5A (Type A)



LEGENDA  
LEGEND

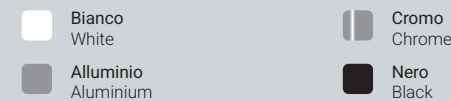

Immagini puramente indicative. Consultare il Listino Prezzi.  
Purely indicative images. See Price List.



Passacavi verticale a spirale  
Vertical spiral cable duct

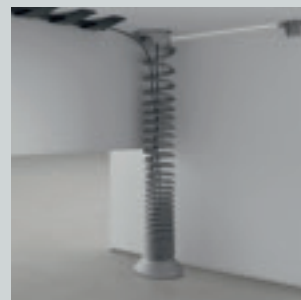

Canalina verticale con zip  
Vertical channel with zip

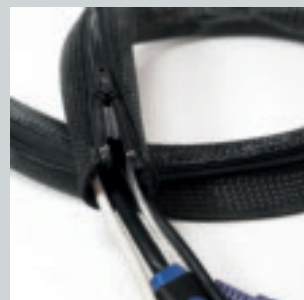

Canale passacavi attrezzabile  
Equippable wire management

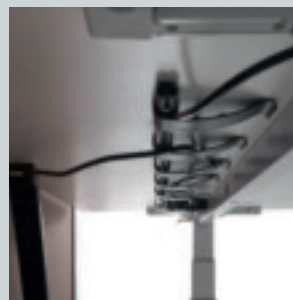

La natura è il motore che sostiene il mondo in cui viviamo. Lavorare in un'ottica green è un impegno e un dovere per avere i piedi radicati a terra nel presente, ma lo sguardo sempre rivolto al futuro.

Per il benessere del domani è indispensabile fare oggi delle scelte sostenibili. Selezioniamo con grande attenzione la qualità dei materiali dei nostri prodotti e soddisfiamo gli standard più rigorosi: prodotti durevoli e sostenibili. Una costante ricerca per un miglioramento continuo nei processi produttivi di ogni nostra attività: essere green è la nostra natura, non solo parole.

Ecco i fatti: le nostre certificazioni aziendali e di prodotto, sono in costante aggiornamento, poiché essere green vuol dire soprattutto sapersi sempre rinnovare per crescere.

Nature is the engine that sustains the world we live in. Working in a green perspective is a commitment and a duty to have one's feet firmly rooted in the present, but one's gaze always turned towards the future.

For the well-being of tomorrow, it is essential to make sustainable choices today. We carefully select the quality of the materials in our products and meet the strictest standards: durable and sustainable products. Constant research for continuous improvement in the production processes of all our activities: being green is our nature, not just words.

Here are the facts: our company and product certifications are constantly being updated, because being green means above all always knowing how to renew in order to grow.

Scopri le nostre certificazioni:  
Discover our certifications:

